

# Canon EF LENS

EF300mm f/2.8L IS USM

EF400mm f/2.8L IS USM

EF500mm f/4L IS USM

EF600mm f/4L IS USM



IMAGE STABILIZER

ENG

Instructions

## Thank you for purchasing a Canon product.

Canon's EF300mm f/2.8L IS USM, EF400mm f/2.8L IS USM, EF500mm f/4L IS USM and EF600mm f/4L IS USM are high-performance super-telephoto lenses, for use with EOS cameras.

- "IS" stands for Image Stabilizer.
- "USM" stands for Ultrasonic Motor.

### Handling Cautions

- **If the lens is taken from a cold environment into a warm one, condensation may develop on the lens surface and internal parts.** To prevent condensation in this case, first put the lens into an airtight plastic bag before taking it from a cold to warm environment. Then take out the lens after it has warmed gradually. Do the same when taking the lens from a warm environment into a cold one.  
Do not stand on top of the lens case. You may fall and injure yourself.  
Do not pile lens cases on top of one another as they may fall and cause injury.
- Do not leave the lens in excessive heat such as in a car in direct sunlight. **High temperatures can cause the lens to malfunction.**

### Features

1. The Image Stabilizer gives the equivalent effect of a shutter speed two stops\* faster.
2. Use of fluorite and UD lens elements giving superior definition.
3. Ultrasonic motor (USM) for fast, quiet autofocus.
4. Manual focusing is available after the subject comes into focus in autofocus mode (ONE SHOT AF).
5. An AF stop button to pause autofocus whenever desired.
6. Can be used with EF1.4× II/EF2× II extenders.
7. A focus preset function for advance storage of focusing positions in memory to allow instantaneous focusing.
8. Tight seal structure ensures excellent dustproof and drip-proof performance.
9. Designed for lighter weight with parts made of magnesium alloy.

\* Based on [1/focal length] second.  
Generally, it requires a shutter speed [1/focal length] second or faster to prevent camera shake.

# ! Safety Precautions

## ! Safety Precautions

- **Do not look at the sun or a bright light source through the lens or camera.** Doing so could result in loss of vision. Looking at the sun directly through the lens is especially hazardous.
- **Whether it is attached to the camera or not, do not leave the lens under the sun without the lens cap attached.** This is to prevent the lens from concentrating the sun's rays, which could cause a fire.

This device complies with Part 15 of the FCC Rules. Operation is subject to the following two conditions: (1) This device may not cause harmful interference, and (2) this device must accept any interference received, including interference that may cause undesired operation.

Do not make any changes or modifications to the equipment unless otherwise specified in the instructions. If such changes or modifications should be made, you could be required to stop operation of the equipment.

This equipment has been tested and found to comply with the limits for a class B digital device, pursuant to part 15 of the FCC Rules. These limits are designed to provide reasonable protection against harmful interference in a residential installation. This equipment generates, uses and can radiate radio frequency energy and, if not installed and used in accordance with the instructions, may cause harmful interference to radio communications.

However, there is no guarantee that interference will not occur in a particular installation. If this equipment does cause harmful interference to radio or television reception, which can be determined by turning the equipment off and on, the user is encouraged to try to correct the interference by one or more of the following measures:

- Reorient or relocate the receiving antenna.
- Increase the separation between the equipment and receiver.
- Consult the dealer or an experienced radio/TV technician for help.

This Class B digital apparatus complies with Canadian ICES-003.

### Conventions used in this instruction



Warning to prevent lens or camera malfunction or damage.



Supplementary notes on using the lens and taking pictures.

## Attaching the strap

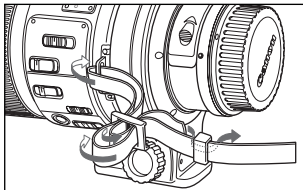

Thread the end of the strap through the strap mount on the lens and then back through the clasp on the strap. Pull the strap tight and check that there is no slack in the clasp.

# Nomenclature

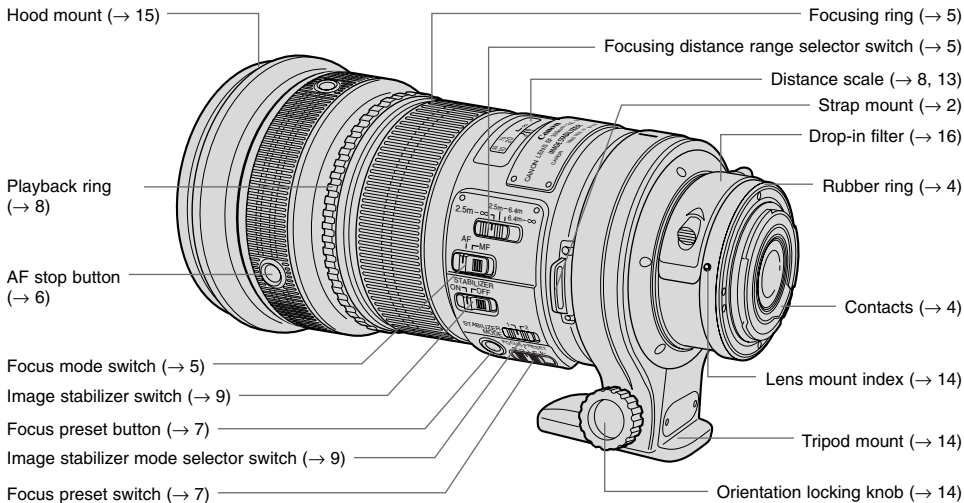

- The illustrations used in the explanations in this manual show the EF300mm f/2.8L IS USM, but the EF400mm f/2.8L IS USM, the EF500mm f/4L IS USM, and the EF600mm f/4L IS USM are all used in the same way.
- For detailed information, reference page numbers are provided in parentheses (→ \*\*).

# 1. Mounting and Detaching the Lens

See your camera's instructions for details on mounting and detaching the lens.

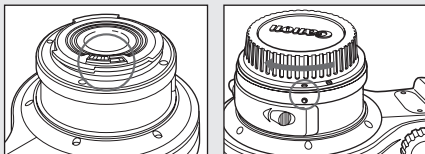

- After detaching the lens, place the lens with the rear end up to prevent the lens surface and contacts from getting scratched.
- If the contacts get soiled, scratched, or have fingerprints on them, corrosion or faulty connections can result. The camera and lens may not operate properly.
- If the contacts get soiled or have fingerprints on them, clean them with a soft cloth.
- If you remove the lens, cover it with the dust cap. To attach it properly, align the lens mount index and the  index of the dust cap as shown in the diagram, and turn clockwise. To remove it, reverse the order.



The lens mount has a rubber ring for enhanced dust- and water-resistance. The rubber ring may cause slight abrasions around the camera's lens mount, but this will not cause any problems. If the rubber ring becomes worn, it is replaceable by a Canon Service Center at cost.

## 2. Setting the Focus Mode

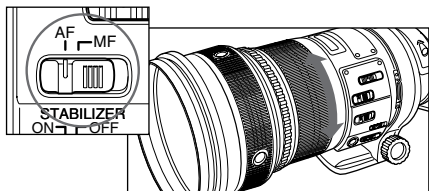

To shoot in autofocus (AF) mode, set the focus mode switch to AF.

To shoot in manual focus (MF) mode, set the focus mode switch to MF, and focus by turning the focusing ring. The focusing ring always works, regardless of the focus mode.

 After autofocus in ONE SHOT AF mode, focus manually by pressing the shutter button halfway and turning the focusing ring. (Full-time manual focus)

## 3. Switching the Focusing Distance Range

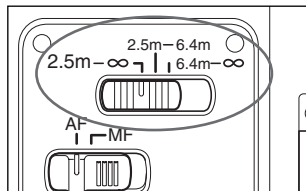

You can set the focusing distance range with a switch. By setting a suitable focusing distance range, the actual autofocus time will be shorter.

| Lens                  | Ranges                           |
|-----------------------|----------------------------------|
| EF300mm f/2.8L IS USM | 2.5 m/8.2 ft. – ∞                |
|                       | 2.5 m/8.2 ft. – 6.4 m/21.0 ft.   |
|                       | 6.4 m/21.0 ft. – ∞               |
| EF400mm f/2.8L IS USM | 3 m/9.8 ft. – ∞                  |
|                       | 3 m/9.8 ft. – 10 m/32.8 ft.      |
|                       | 10 m/32.8 ft. – ∞                |
| EF500mm f/4L IS USM   | 4.5 m/14.8 ft. – ∞               |
|                       | 4.5 m/14.8 ft. – 10 m/32.8 ft.   |
|                       | 10 m/32.8 ft. – ∞                |
| EF600mm f/4L IS USM   | 5.5 m/18.0 ft. – ∞               |
|                       | 5.5 m/18.0 ft. – 16.2 m/53.2 ft. |
|                       | 16.2 m/53.2 ft. – ∞              |

## Switching the Focusing Distance Range

ⓘ If you use AF from outside the specified focusing distance range, the lens may stop focusing when it reaches the limit of the range. This is not a malfunction. If this occurs, press the shutter button halfway down again.

## 4. AF Stop Button

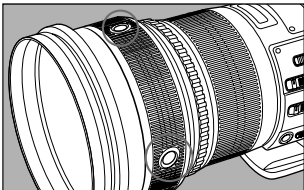

During autofocus operation, you can press the AF stop button to temporarily pause autofocus.

If the shutter button is still pressed halfway when the AF stop button is released, autofocus will continue as before.

## AF Stop Button

ⓘ The AF stop function also works in AI Servo AF mode.

- With the EOS 630/600, RT, A2/A2E/5, or 10S/10 set to the AI Servo AF mode and continuous shooting, AF will not resume even after you let go of the AF stop button. Press the shutter release button halfway to resume AF.
- With the EOS A2/A2E/5 and 10S/10 set to the Sports mode, AF will not resume even after you let go of the AF stop button. Press the shutter release button halfway to resume AF.
- You can change the functions of the AF stop button using the camera's Custom Function. For details, please refer to the camera's instructions.

## 5. Focus Preset

By presetting any focusing distance, you can instantly focus at that point even while you are shooting a different subject. This function operates in both the AF and MF modes.

### < How to Set >

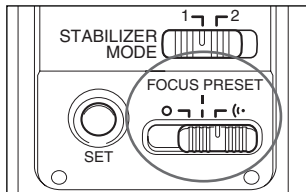

**1** Set the focus preset switch to I or ∞.

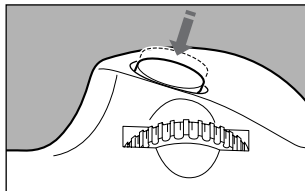

**2** Press the shutter button halfway to focus the distance you want to preset.

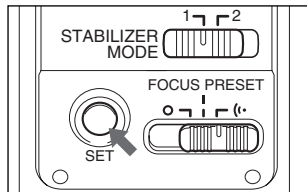

**3** Press the focus preset button.

- The focused distance will be preset.
- If the focus preset switch was set to ∞, the beeper will sound once.



### < How to Focus at the Preset Distance >

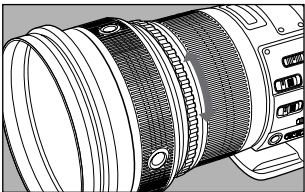

While turning the playback ring to the left or right, press the shutter button completely.

- The lens will focus at the preset distance.
- If the focus preset switch was set to (L), the beeper will sound twice.

- ⓘ ● When turning the playback ring, keep your finger away from the shutter button. In One-Shot AF mode, the exposure will be locked when you press the shutter button halfway and focus is achieved. So if you press the shutter button halfway while turning the playback ring, the exposure may not be correct.
- When not using the focus preset, set the switch to (O) .

- ⓘ In the following cases, the focusing distance scale will move slightly. It will not affect the image.
  - When you press the focus preset button.
  - When you turn the playback ring.

## 6. Image Stabilizer

You can use the image stabilizer in AF or MF mode.

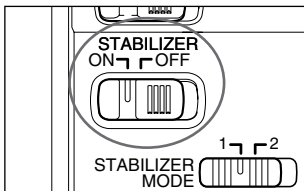

**1** Set the STABILIZER switch to ON.

- If you are not going to use the image stabilizer function, set the switch to OFF.

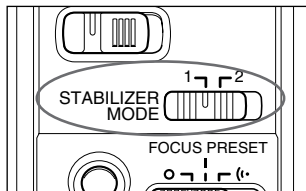

**2** Select the stabilizer mode.

- **MODE 1:** Corrects vibrations in all directions. It is mainly effective for shooting still subjects.
- **MODE 2:** Corrects vertical camera shake during following shots in a horizontal direction, and corrects horizontal camera shake during following shots in a vertical direction.

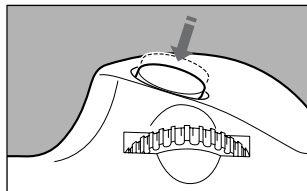

**3** Press the shutter button down halfway to enable stabilization.

- Make sure the image in the viewfinder is stable, then press the shutter button the rest of the way down to take the picture.

## 7. Tips on Using the Image Stabilizer

The image stabilizer for this lens is effective for hand-held shots in the following conditions.

### ● MODE 1



ON

OFF

- In semi-darkened areas such as indoors or outdoors at night.
- In locations where flash photography is prohibited, such as art museums and theater stages.
- In situations where your footing is uncertain.
- In situations where fast shutter settings cannot be used.

### ● MODE 2



ON

OFF

- When panning subjects in motion.

## Tips on Using the Image Stabilizer

- The Image Stabilizer cannot compensate for a blurred shot caused by a subject that moved.
- Set the STABILIZER switch to OFF when you are taking pictures using the Bulb setting (long exposures). If the STABILIZER switch is set to ON, the image stabilizer function may introduce errors.
- The Image Stabilizer might not be fully effective in the following cases:
  - You shoot from a violently moving vehicle.
  - You move the camera dramatically for a panning shot in Mode 1.
  - You shoot using techniques other than following shots in Mode 2.
- The Image Stabilizer consumes more power than normal shooting, so fewer shots can be taken if you use the function.
- The image stabilizer operates for about two seconds even when your finger is off the shutter button. Do not remove the lens while the stabilizer is in operation. This will cause a malfunction.
- With the EOS-1V/HS, 3, ELAN 7E/ELAN 7/30/33, ELAN 7NE/ELAN 7N/30V/33V, ELAN II/ELAN II E/50/50E, REBEL 2000/300, IX, IX Lite/IX7, and D30, the Image Stabilizer will not work during self-timer operation.



- When you use a tripod, the Image Stabilizer should be turned off to save battery power.
- The stabilizer is equally effective for hand-held photography and photography with a monopod.
- The Image Stabilizer also operates when the lens is used with extension tube EF12 II or EF25 II or the extender EF1.4× II.
- The Image Stabilizer also operates when the EF300mm f/2.8L IS USM or EF400mm f/2.8L IS USM is used with the extender EF2× II.

## Tips on Using the Image Stabilizer



- When using the extender EF2× II with the EF500mm f/4L IS USM or EF600mm f/4L IS USM, you can use the Image Stabilizer with the following cameras: EOS-1Ds Mark III, EOS-1Ds Mark II, EOS-1Ds, EOS-1D Mark III, EOS-1D Mark II N, EOS-1D Mark II, EOS-1D, EOS 40D, 30D, 20D, 20Da, 10D, 5D, EOS DIGITAL REBEL XSi/EOS 450D, EOS DIGITAL REBEL XTi/400D DIGITAL, EOS DIGITAL REBEL XT/350D DIGITAL, EOS DIGITAL REBEL/300D DIGITAL, EOS D60, D30, EOS DCS1, DCS3, D2000, D6000, EOS-1V/HS, EOS-1N/DP/HS/RS, 3, ELAN 7E/ELAN 7/30/33, ELAN 7NE/ELAN 7N/30V/33V, ELAN II/ELAN II E/50/50E, 3000/88, REBEL XS/500, REBEL 2000/300, REBEL Ti/300V, REBEL T2/300X, REBEL K2/3000V, IX, IX Lite/IX7
- Depending on the camera there may be image shake, such as after releasing the shutter. However, this does not affect shooting.
- If you set the camera's Custom Function to change the assigned button to operate the AF, the Image Stabilizer will operate when you press the newly assigned AF button.

## 8. Infinity Compensation Mark

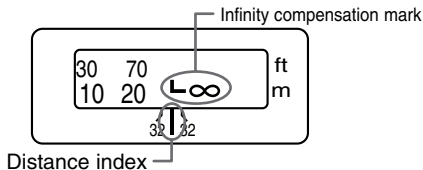

To compensate for shifting of the infinity focus point that results from changes in temperature. The infinity position at normal temperature is the point at which the vertical line of the L mark is aligned with the distance indicator on the distance scale.

- For accurate focusing in MF on subjects at infinity distance, look through the viewfinder while rotating the focusing ring.

## 9. Depth-of-Field Scale

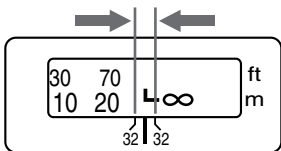

The depth of field is the distance in front of and behind the plane of focus on the subject that appears sharp. The depth of field is indicated by the area between the depth-of-field scale lines below the distance scale. The numbers on the scale are F values.

 The depth-of-field scale is an approximate indicator.

## 10. Using the Tripod Mount

### Adjusting the Tripod Mount

By loosening the orientation locking knob on the tripod mount you can rotate the camera to set the image for any vertical or horizontal position.

### Detaching the Tripod Mount (EF300mm f/2.8L IS USM only)

First remove the lens from the camera and then remove the tripod mount from the lens as shown below. To attach the tripod mount, reverse the procedure.

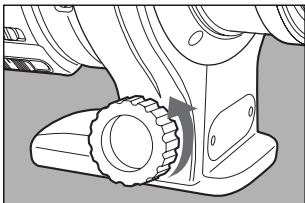

- 1** Loosen the orientation locking knob.

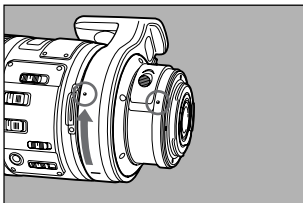

- 2** Align the red mark on the tripod mount with the lens mount index.

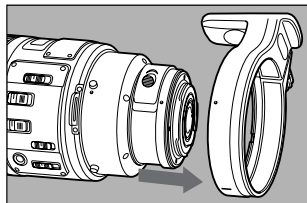

- 3** Slide off the tripod collar away from the rear of the lens.

## 11. Hood

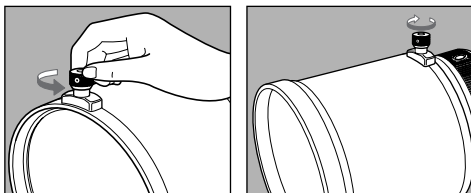

The special hoods that come with all these lenses cut out unwanted light and protect the front of the lens from rain, snow, and dust.

To attach the hood, loosen the hood lock knob by turning it counterclockwise. Fit the hood onto the lens's hood mount, and tighten the lock knob to fix it in place. Use the same procedure, in reverse, to remove the hood.

## 12. Case

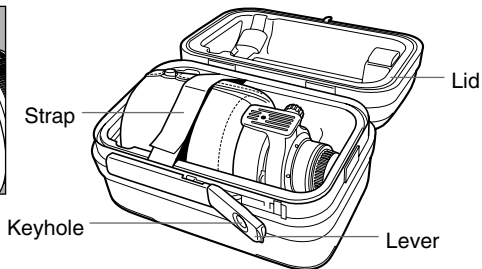

Put the lens away as follows.

- 1** Reverse the lens hood, slip it over the lens, and attach the lens cap.
- 2** Position the tripod mount straight upwards as shown and place it in the case.
- 3** Fasten the lens securely with the strap.
- 4** Push the lever while holding the lid from above to lock.



## 13. Drop-In Filters

A 52-series drop-in gelatin filter holder with a glass filter is included with the lens. The drop-in filter holder can be used fitted with a gelatin filter (sold separately).

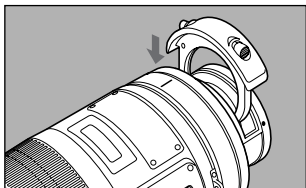

### <Installing and Removing>

To remove the drop-in filter, press in the left and right lock buttons and pull the filter holder straight out of the slot.

To install the drop-in filter, push the filter holder straight down into the slot until it clicks into place.

- The filter holder can be installed facing either forwards or backwards.

**!** Because the lens optics are designed to include a glass filter, you must always install the filter holder, even if no gelatin filter is fitted.

### <Using a Gelatin Filter>

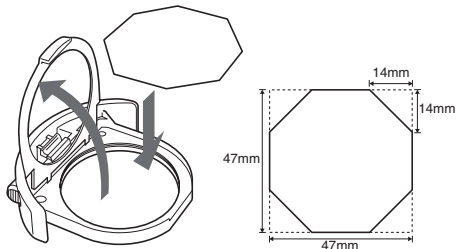

- 1 Lift up the holder's retaining plate.
- 2 Cut the gelatin filter as shown and mount it in the holder.
- 3 Return the retaining plate to its closed position.

 The Drop-In Screw-Type Filter Holder 52 and Drop-In Circular Polarizing Filter PL-C52 are also available (sold separately).

## 14. Extenders (Sold Separately)

Lens specifications when using extender EF1.4× II/EF2× II are as follows.

|                           |            | EF300mm f/2.8L IS USM |            | EF400mm f/2.8L IS USM |            |
|---------------------------|------------|-----------------------|------------|-----------------------|------------|
|                           |            | EF1.4× II             | EF2× II    | EF1.4× II             | EF2× II    |
| Focal length (mm)         |            | 420                   | 600        | 560                   | 800        |
| Aperture                  |            | f/4 – 45              | f/5.6 – 64 | f/4 – 45              | f/5.6 – 64 |
| Angle of view             | Diagonal   | 6° 10'                | 4° 10'     | 4° 25'                | 3° 5'      |
|                           | Vertical   | 3° 20'                | 2° 20'     | 2° 25'                | 1° 40'     |
|                           | Horizontal | 5°                    | 3° 30'     | 3° 40'                | 2° 35'     |
| Maximum magnification (×) |            | 0.19                  | 0.28       | 0.22                  | 0.31       |

|                           |            | EF500mm f/4L IS USM |          | EF600mm f/4L IS USM |          |
|---------------------------|------------|---------------------|----------|---------------------|----------|
|                           |            | EF1.4× II           | EF2× II  | EF1.4× II           | EF2× II  |
| Focal length (mm)         |            | 700                 | 1000     | 840                 | 1200     |
| Aperture                  |            | f/5.6 – 45          | f/8 – 64 | f/5.6 – 45          | f/8 – 64 |
| Angle of view             | Diagonal   | 3° 30'              | 2° 30'   | 3°                  | 2°       |
|                           | Vertical   | 2°                  | 1° 20'   | 1° 40'              | 1° 10'   |
|                           | Horizontal | 3°                  | 2°       | 2° 30'              | 1° 40'   |
| Maximum magnification (×) |            | 0.17                | 0.25     | 0.17                | 0.24     |

-  Attach the extender to the lens, and then attach the lens to the camera. To remove it, reverse the order. Errors may occur if you attach the extender to the camera first.
- When using the extender EF2× II with the EF500mm f/4L IS USM or EF600mm f/4L IS USM, the focusing mode is MF mode. However, AF shooting is possible only with the center focusing point when the camera is EOS-1Ds Mark III, EOS-1Ds Mark II, EOS-1Ds, EOS-1D Mark III, EOS-1D Mark II N, EOS-1D Mark II, EOS-1D, EOS-1V/HS, or EOS-3.

## Extenders (Sold Separately)

- When shooting with EOS A2/A2E/5 fitted with either the EF300mm f/2.8L IS USM or EF400mm f/2.8L IS USM, use  $-0.5$  step exposure compensation when using extender EF1.4 $\times$  II, and use  $-1$  step exposure when using extender EF2 $\times$  II.
- When taking pictures on an EOS A2/A2E/5 using an EF1.4 $\times$  II/EF2 $\times$  II extender with the EF500mm f/4L IS USM or the EF600mm f/4L IS USM, use the values in the table below for exposure compensation.

|                                  | EF1.4 $\times$ II | EF2 $\times$ II |
|----------------------------------|-------------------|-----------------|
| Evaluative metering              | $-0.5$ step       | $-1$ step       |
| Center-weighted average metering | $-0.5$ step       | $-1$ step       |
| Spot metering                    | —                 | $-0.5$ step     |

- Extenders cannot be used more than one at a time.



- AF is possible with extender EF1.4 $\times$  II.
- When an extender is attached, the AF speed will become slower to retain proper control.

## 15. Extension Tubes (Sold Separately)

You can attach extension tube EF12 II or EF25 II for magnified shots. The shooting distance and magnification are shown below.

| Focusing Distance Range (mm) |               | Magnification ( $\times$ ) |               |
|------------------------------|---------------|----------------------------|---------------|
| Close distance               | Long distance | Close distance             | Long distance |

### EF300mm f/2.8L IS USM

|         |      |      |      |      |
|---------|------|------|------|------|
| EF12 II | 2016 | 7561 | 0.18 | 0.04 |
| EF25 II | 1687 | 3731 | 0.24 | 0.09 |

### EF400mm f/2.8L IS USM

|         |      |       |      |      |
|---------|------|-------|------|------|
| EF12 II | 2602 | 13633 | 0.19 | 0.03 |
| EF25 II | 2314 | 6974  | 0.23 | 0.06 |

### EF500mm f/4L IS USM

|         |      |       |      |      |
|---------|------|-------|------|------|
| EF12 II | 3856 | 21193 | 0.15 | 0.03 |
| EF25 II | 3391 | 10778 | 0.18 | 0.05 |

### EF600mm f/4L IS USM

|         |      |       |      |      |
|---------|------|-------|------|------|
| EF12 II | 4777 | 29195 | 0.14 | 0.02 |
| EF25 II | 4182 | 13944 | 0.17 | 0.05 |



MF mode is recommended for accurate focusing.

# Specifications

|                                 | <b>EF300mm f/2.8L IS USM</b>                                | <b>EF400mm f/2.8L IS USM</b>                               |
|---------------------------------|---|--|
| <b>Focal Length/Aperture</b>    | 300 mm f/2.8  | 400 mm f/2.8   |
| <b>Lens Construction</b>        | 13 groups, 17 elements                                      | 13 groups, 17 elements                                     |
| <b>Minimum Aperture</b>         | f/32  | f/32   |
| <b>Angle of View</b>            | Diagonal: 8° 15'<br>Vertical: 4° 35'<br>Horizontal: 6° 50'  | Diagonal: 6° 10'<br>Vertical: 3° 30'<br>Horizontal: 5° 10' |
| <b>Min. Focusing Distance</b>   | 2.5 m/8.2 ft.   | 3 m/9.8 ft.  |
| <b>Max. Magnification</b>       | 0.13×   | 0.15×  |
| <b>Field of View</b>            | Approx. 176 × 264 mm/<br>6.9 × 10.4 inch (at 2.5 m/8.2 ft.) | Approx. 155 × 233 mm/<br>6.1 × 9.2 inch (at 3 m/9.8 ft.)   |
| <b>Filter</b>                   | Any 52-series drop-in filter                                |  |
| <b>Max. Diameter and Length</b> | 128 × 252 mm/5.0 × 9.9 inch                                 | 163 × 349 mm/6.4 × 13.7 inch                               |
| <b>Weight</b>                   | 2550 g/90.0 oz  | 5370 g/189.4 oz  |
| <b>Hood</b>                     | ET-120  | ET-155   |
| <b>Lens Cap</b>                 | E-145   | E-180C   |
| <b>Case</b>                     | Lens case 300   | Lens case 400  |

- The lens length is measured from the mount surface to the front end of the lens. Add 26.5 mm when including the lens cap and dust cap.
- The size and weight listed are for the lens only, except as indicated.
- The Close-up Lenses 250D and 500D cannot be attached.
- Aperture settings are specified on the camera.
- All data listed is measured according to Canon standards.
- Product specifications and appearance are subject to change without notice.

## Specifications

|                                 | <b>EF500mm f/4L IS USM</b>                                   | <b>EF600mm f/4L IS USM</b>                                   |
|---------------------------------|--|--|
| <b>Focal Length/Aperture</b>    | 500 mm f/4   | 600 mm f/4   |
| <b>Lens Construction</b>        | 13 groups, 17 elements                                       | 13 groups, 17 elements                                       |
| <b>Minimum Aperture</b>         | f/32   | f/32   |
| <b>Angle of View</b>            | Diagonal: 5°<br>Vertical: 2° 45'<br>Horizontal: 4°           | Diagonal: 4° 10'<br>Vertical: 2° 20'<br>Horizontal: 3° 30'   |
| <b>Min. Focusing Distance</b>   | 4.5 m/14.8 ft.   | 5.5 m/18.0 ft.   |
| <b>Max. Magnification</b>       | 0.12×  | 0.12×  |
| <b>Field of View</b>            | Approx. 197 × 297 mm/<br>7.8 × 11.7 inch (at 4.5 m/14.8 ft.) | Approx. 204 × 306 mm/<br>8.0 × 12.1 inch (at 5.5 m/18.0 ft.) |
| <b>Filter</b>                   | Any 52-series drop-in filter                                 |  |
| <b>Max. Diameter and Length</b> | 146 × 387 mm/5.8 × 15.2 inch                                 | 168 × 456 mm/6.6 × 18.0 inch                                 |
| <b>Weight</b>                   | 3870 g/136.5 oz  | 5360 g/189.0 oz  |
| <b>Hood</b>                     | ET-138   | ET-160   |
| <b>Lens Cap</b>                 | E-163  | E-185  |
| <b>Case</b>                     | Lens case 500  | Lens case 600  |

**Canon**