

SEKONIC

Operating Manual

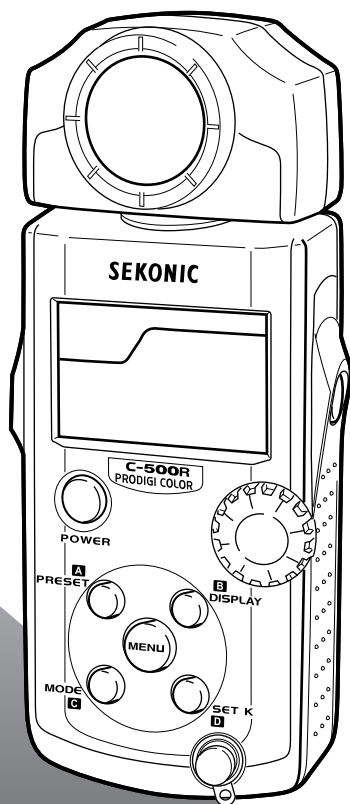

PRODIGI COLOR
C-500R/C-500

Congratulations on your purchase of a Sekonic PRODIGI COLOR C-500R/C-500

Congratulation on your purchase of the Sekonic Prodigy Color C-500R/C-500 color meter.

Please read the operating manual carefully to properly utilize the many features and benefits of this precision instrument.

The Prodigy Color C-500R/C-500 is the most advanced and sophisticated color meter in the industry. Combining the latest micro-processing technology with years of light measuring expertise, Sekonic has addressed the needs of today's Pro digital shooter.

The Prodigy Color C-500R/C-500 is designed to offer both digital and film shooters a new level of precision, accurate color measurement and exact control. It is the world's first color meter to offer selectable digital or film color sensitivity measurement. In addition, the Prodigy Color C-500R/C-500 offers the advantage and convenience of built-in PocketWizard wireless radio triggering.

With its' large illuminated LCD screen, the Prodigy Color provides easily selectable Kelvin settings, LB & CC filter numbers and index compensation, LUX or Foot-Candle light measurements, selectable wireless radio triggering channels and Quad-Triggering Zones, Custom settings and many more desirable features.

By utilizing its four color sensors, the Prodigy Color C-500R/C-500 provides color correction that ensures images with accurate color reproduction. Color measurements are available for both flash and ambient light sources.

To receive the greatest benefit from the expansive features of the Prodigy Color C-500R/C-500, it is recommended that you read the following operating manual. This manual has been organized to help familiarize you with the full potential of the Prodigy Color C-500R/C-500. Once you have become accustomed to the features and functions that are most important to you, the manual may be used as a quick reference guide.

As with all Sekonic products, the Prodigy Color C-500R/C-500 has undergone extensive quality control throughout every step of the manufacturing process. Please follow the recommend operating procedures for years of reliable performance.

Thank you for investing in Sekonic.

Included Accessories

The following items are included with the Prodigy Color C-500R/C-500. After opening the package, please be sure that everything is included. If any of the following items should be missing, please contact your local camera store or retail organization.

Sync Terminal Cap
(attached to main unit)



Neck Strap



Quick Guide

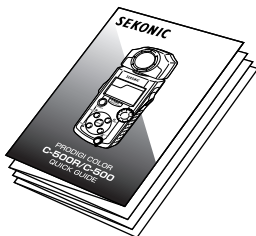

Operating Manual
(this document)



Two AA batteries (dry cell alkaline)

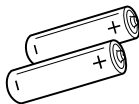

Soft Case

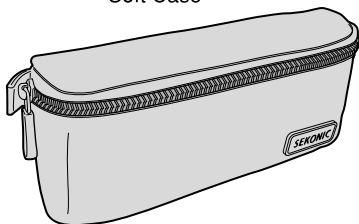





Table of Contents

■ Included Accessories	j
■ Safety Precautions	1
1. Parts Designations and Functions	2
1-1. Parts Designations	2
1-2. Parts Functions.....	3
2. Explanation of LCD screen information.....	4
3. Before Use.....	6
3-1. Attaching the Strap.....	6
3-2. Installing the Batteries	6
4. Turning the Power On.....	7
4-1. Power ON/OFF	7
4-2. Checking the Battery Capacity.....	7
4-3. Warnings About Changing the Batteries During Measurement.....	8
4-4. Automatic Power OFF Function	8
5. Basic Operation.....	9
5-1. Basic Operation Flowchart	9
5-2. Digital / Film Settings	10
5-3. Setting the Measuring Mode	11
5-4. Setting the Display Mode	12
5-5. Setting the Selected Color Temperature	14
5-6. Setting the Shutter Speed (Flash Modes Only)	15
5-7. Selecting Preset White Balance/Color Compensation.....	16
6. Measurement	17
6-1. Measurement Method	17
6-2. Measurement in Ambient Light Mode.....	18
6-3. Measurement in Cordless Flash Mode.....	19
6-4. Measurement in Cord Flash Mode	21
6-5. Measurement in Wireless Radio Triggering Mode (C-500R Only).....	23
6-5-1. Selecting Radio Triggering Channel and Quad-Triggering Zone Mode	23
6-5-2. Measurement in Wireless Radio Triggering Mode	25
6-6. Selecting Flash Measurement Range (Flash Modes Only)	28
6-7. Out of Display Range / Measurement Range	29
6-7-1. Out of Display Range	29
6-7-2. Out of Measurement Range	30

7. Other Functions	31
7-1. Memory Function	31
7-2. Jog Wheel Lock / Release	32
8. Menu Settings	33
8-1. Menu Reference	33
8-2. Digital / Film Settings	36
8-3. Selecting Flash Measurement Range	36
8-4. Preset White Balance/Color Compensation	36
8-4-1. Setting and Saving Preset Data	37
8-4-2. Clearing Preset Data	40
8-5. Custom Settings	41
9. Optional Accessories	44
10. Specifications	45
11. Appendix	47
11-1. Glossary	47
11-2. Exposure Correction when Using Filters	48
12. Cautions when Using this Product	49
FCC & IC Compliance Information	50
Manufacturer's EC Declaration of Conformity	51

Safety Precautions

Before using this product, please read this “Safety Precautions” for proper operation.

 Warning	The warning symbol indicates the possibility of death or serious injury if the product is not used properly.
 Caution	The caution symbol indicates the possibility of minor to moderate personal injury or product damage if the product is not used properly.
 Note	The note symbol indicates cautions or restrictions when using the product. Please read all notes to avoid errors in operation.
 Reference	The reference symbol indicates additional information about the controls or related functions. Reading these is recommended.

Warning

- Infants or toddlers may accidentally wrap the strap around their neck, so please place it in a location out of their reach. There is a danger of suffocation.
- Infants or toddlers may accidentally swallow the sync terminal cap, so please place it in a location out of their reach. There is a danger of suffocation.
- Do not place batteries in open flame, attempt to short them, disassemble them, apply heat to them, or recharge them (except rechargeable batteries). They may burst and cause fires, serious injury, or damage to the environment.

Caution

- Do not handle this product with wet hands, or leave it in the rain or in a location where it may be splashed with water or come into contact with moisture. There is a danger of electric shock if the “Cord Flash Mode” is used. This may also result in damage to the product.
- Do not attempt to disassemble the product for modification or parts replacement. Refer servicing only to qualified and authorized personnel in case of product’s malfunction.

1 Parts Designations and Functions

1-1. Parts Designations

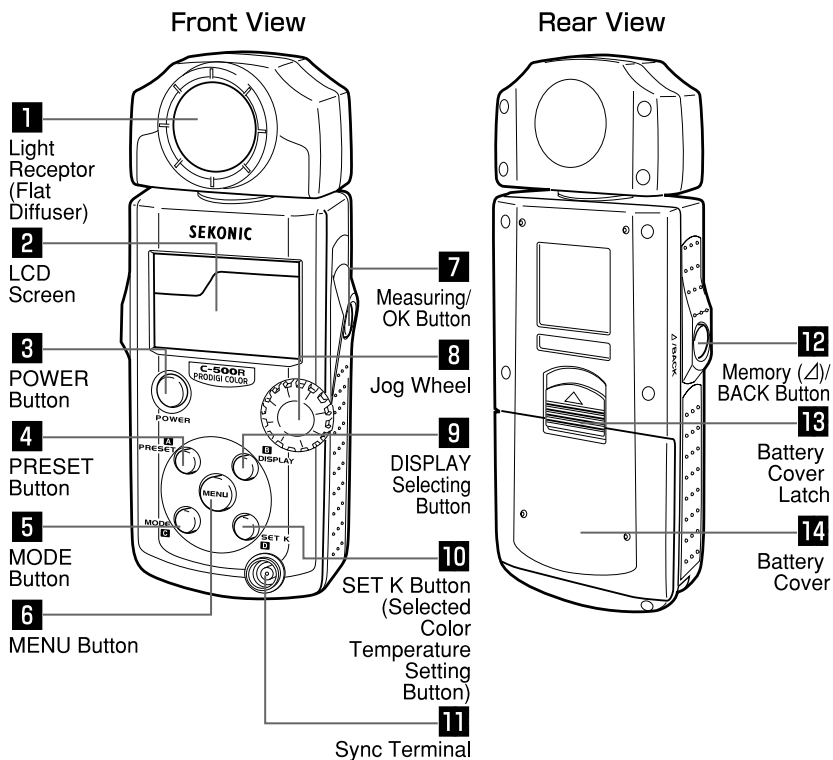

Battery Cover Open

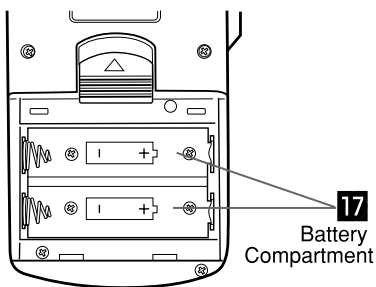

Bottom View

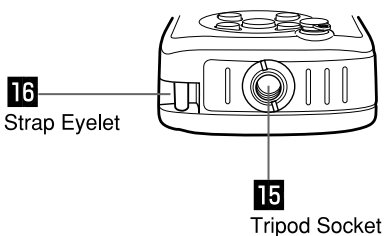

1-2. Parts Functions

The following table lists the functions of each part.

No.	Part Name	Explanation
1	Light Receptor (Flat Diffuser)	Point light receptor directly at light source during reading. Recommended to measure light sources individually. Head rotates 270 degrees to aid reading.
2	LCD screen	Illuminated screen displays Color temperature (Kelvin), Illuminance (FC/LUX), LB/CC index and Filter number values. Indicates user settings for Film/Digital mode, ambient/flash measurement, selected color temperature, and preset color compensation. (See P4).
3	POWER Button	Press to turn ON/OFF. Auto OFF after 20 minutes. (Selectable in custom settings).
4	PRESET Button	Press and hold while turning Jog Wheel to select user-set color compensation. Alpha numeric display to input user-set light source types. (See P16). Note: The Preset button has no function in Display Mode when taking a color temperature or simplified illuminance measurement.
5	MODE Button	Press and hold while turning Jog Wheel to select Ambient/Flash measuring mode or Wireless radio triggering (PocketWizard) channel. (See P11).
6	MENU Button	Press to enter Menu mode for setting Film/Digital mode, Preset White Balance / Color Comp., Custom Settings, Flash Measurement Range. (See P33).
7	Measuring/OK Button	Press for measurement. Used in MENU mode to select and lock.
8	Jog Wheel	Turn to select modes, menus and settings.
9	DISPLAY Selecting Button (Blue)	Press to change display to Color Temperature (Kelvin), Simplified Illuminance (FC/LUX), LB/CC index, and Filter number values in LCD screen. (See P12).
10	SET K Button (Selected Color Temperature Setting Button)	Press and hold while turning Jog Wheel to select Selected Color Temperature (Kelvin). (See P14). Note: The SET K button has no function in Display Mode when taking a color temperature or simplified illuminance measurement.
11	Sync Terminal (with cap)	For measuring flash in Cord Flash Mode with external flash units using optional sync cord.
12	Memory (Δ)/BACK Button	Press to memorize current reading. When measuring button pressed, difference in +/- Kelvin, +/- LB/CC Index or Filter number for MK-1 (Mired) and color filtration, +/- FC/LUX for Illuminance is displayed.(See P31) Press as [BACK] button during Menu mode or settings to return to previous screen.
13	Battery Cover Latch	Latch for the Battery Cover.
14	Battery Cover	Secures two AA size batteries.
15	Tripod Socket	Female mounting threads (1/4-20) for hands free mounting on tripods, light stands or similar devices.
16	Strap Eyelet	Used to attach the included strap.
17	Battery Compartment	Holds two AA size batteries.



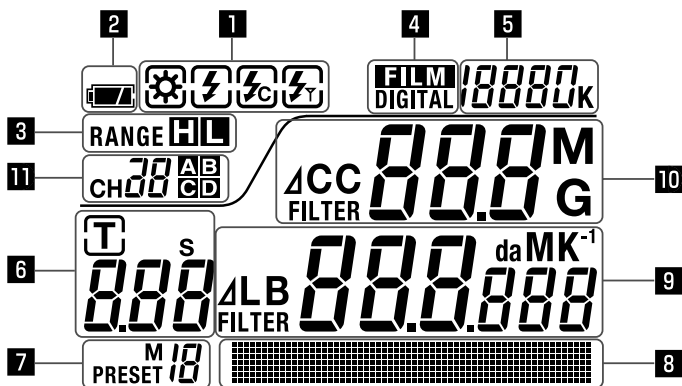

2 Explanation of LCD screen information

Display of the C-500R/C-500*





*This diagram is for explanation purposes.

1 Measuring Mode Icons

-  Ambient Light Mode (See P18)
-  Cordless Flash Mode (See P19)
-  Cord Flash Mode (See P21)
-  Wireless Radio Triggering Mode (C-500R only) (See P23)

2 Battery Capacity Indicator (See P7)

-  Sufficient battery life remaining.
-  Low battery power remaining. Have a spare battery ready.
-  When the indicator blinks, replace the battery immediately.

3 Flash Measurement Range Display (See P28)

- ※ Displayed during Flash Modes only.
- RANGE H** Displayed when “H” is selected.
- RANGE L** Displayed when “L” is selected.

4 Digital / Film Indicator (See P10)

- DIGITAL** Displayed when “Digital” is selected.
- FILM** Displayed when “Film” is selected.

5 Selected Color Temperature Display (See P14)

- 5500k** Displays the selected color temperature.

6 Shutter Speed Display (See P15)

- ※ Displayed during Flash Modes only.
- T** Displays the set shutter speed.
- S** The letter “s” indicates the shutter speed measured in full seconds.
Ex.: “1s” indicates a shutter speed of 1 second, while “60” indicates a shutter speed of 1/60 of a second.

7 Preset Number / Memory (Δ) Display

PRESET  Displayed when selecting Preset White Balance/Color Compensation function.
(Shows preset number from 1 to 19.) (See P16)

M Blinks when the Memory (Δ) function is being used. (See P31)

8 Preset Name, Menu Name, Illuminance Units (Dot Matrix Display)

Dot Matrix characters appear under the following conditions:

1. In Menu Modes - Displays Menu names.
2. While White Balance/Color Compensation is being selected - Displays Preset name.
3. Simplified Illuminance Modes - Displayed only when Lux or Foot-Candle (ambient light) measurement values are selected in the Custom Settings.

9 LB Values, Color Temperature Values, Wireless Radio Triggering Mode Channel Setting (C-500R only)

Depending on the Display Mode, LB index, LB filter number, measured color temperature, or Wireless radio triggering mode channel settings (C-500R only) are displayed.

The simplified illuminance Mode only displays when Lux or Foot-Candle (ambient light) measurement values are selected to display in the custom settings mode.

In case of an out of display range or out of measurement range error, [$\underline{U}nd\overline{e}r$] or [$\overline{O}u\overline{e}r$] appears. (See P29)

$\underline{U}nd\overline{e}r$ Displayed if value is lower than display range.

Blinks if value is lower than measurement range (too dark) or color temperature value is too low.

$\overline{O}u\overline{e}r$ Displayed if value is higher than display range.

Blinks if value is higher than measurement range (too bright) or color temperature value is too high.

10 CC Value Display (See P12)

Depending on the selected display mode, either the CC Value, Index or CC filter number is displayed.

If the measured value exceeds the display range, an out of display range icon [U] or [O] appears (See page 29)

U Displayed if value is lower than display range.

Blinks if value is lower than measurement range (too dark) or color temperature value is too low.

O Displayed if value is higher than display range.

Blinks if value is higher than measurement range (too bright) or color temperature value is too high.

11 Wireless Radio Triggering Mode Channel and Quad-triggering Zone Setting Display (C-500R only) (See P23)

Displayed during Wireless Radio Triggering Mode

For channels 1~16, displays selected main channel.

For channels 17~32, displays selected main channel (17~32) and Selective Quad Triggering zones (A~D).

Automatic Electro-Luminescent (EL) Backlight on LCD screen

If the lighting conditions are dark (approx. EV6, 160lx, 15FC or darker), the LCD screen will automatically illuminate when the Measuring/OK button is pressed. While making or waiting for Cordless flash mode or Wireless radio triggering mode, the LCD screen will not automatically illuminate to avoid interference with the measurement.

The LCD backlight will automatically turn off after 20 seconds if none of the buttons have been pressed. If it becomes necessary to illuminate the LCD backlight, cover the Light receptor (with your hand) and press the MODE button to turn it on.

<Note>Due to the function of EL, it may emit a small typical sound, however, it is not functional default, and no problem as feature.

3 Before Use

3-1. Attaching the Strap

- 1) Pass the strap (included) through the outer hole of the strap eyelet **16**.
- 2) Pass the opposite end of the strap through the loop at the end of the strap.

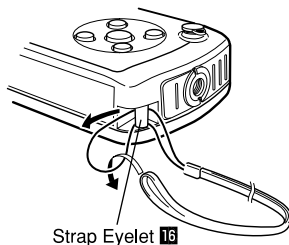

Warning

Infants or toddlers may accidentally wrap the strap around their neck, so please place it in a location out of their reach. There is a danger of suffocation.

3-2. Installing the Batteries

- 1) Prepare two AA batteries.
- 2) Slide the battery cover latch **13** in the direction of the arrow and remove the battery cover **14**.
- 3) Insert the batteries according to the “+” and “-” symbols in the battery compartment **17**.
※As shown in the diagram to the right, please note both positive sides of the batteries are facing in the same direction.
- 4) While lining up the two tabs on the battery cover **14**, press the battery cover **14** back into place from above.

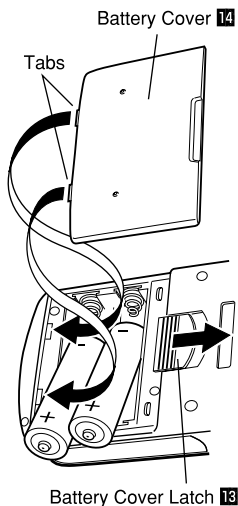

Warning

Do not place batteries in open flame, attempt to short them, disassemble them, apply heat to them, or recharge them (except rechargeable batteries). They may burst and cause fires, serious injury, or damage to the environment.

Caution

- Please insert the batteries minus “-” side first. When removing the batteries, remove them plus “+” side first.
- Do not use batteries with any other rating than the one specified. Also, do not mix old and new batteries.
- If the meter will not be used for an extended period of time, it is recommended to remove the batteries to avoid possible damage caused by battery leaking.

4 Turning the Power On

4-1. Power ON/OFF

Power ON: Press the POWER button **3**. The meter will turn on and the LCD screen will display "Wait..." while the meter runs a self-test. Once the self-test is completed the LCD screen displays the measuring screen. Depending on the mode selected, the "FILM" or "DIGITAL" icon will blink for about 5 seconds.

Power OFF: Press and hold the POWER button **3** in for 1 second or longer and the meter will turn off.

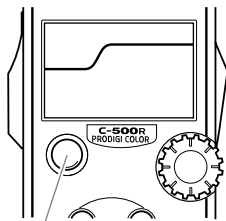

POWER button **3**

! Note

- Please wait 3 seconds between repeated power on and power off sessions.

Reference

- If the LCD screen shows no display, check the battery capacity indicator (See Section 4.2 - Checking the Battery Capacity below). Also check for proper battery insertion (Pos/Neg positioning).
- All settings and measurements made during use are saved in memory even after the meter is powered off.

4-2. Checking the Battery Capacity

When the power is turned ON, the LCD screen will show a battery capacity indicator.



Sufficient battery power remaining.



Low battery power remaining. Have a spare battery ready



When the indicator blinks, replace the battery immediately.

Reference

- When the batteries are out of power and the meter is turned ON, the LCD screen will appear and then turn off immediately. This is an indication that the batteries are depleted and they should be replaced immediately. Having spare batteries on hand is recommended.
- When the meter is continuously used at room temperature, the battery life with alkaline batteries should last 12 hours (based on our testing).
- Due to temperature and length of time stored, the batteries included with this meter may have a shorter live span.

4-3. Warnings about Changing Batteries during Measurement

- 1) Please make sure the power is OFF when replacing batteries.
- 2) If an unexpected display appears on the LCD during battery replacement or measurement, ie. settings other than selected, or if the meter does not respond when a button is pressed, remove the batteries, wait at least 10 seconds, and then re-install them.

4-4. Automatic Power OFF Function

To save battery capacity, the meter will automatically turn off 20 minutes after the last button is pressed.

Reference

- All settings and measurements are saved in memory even after the meter has automatically turned off. When the power is turned ON, they will be displayed again.
- The automatic power off time setting can be selected according to your needs in custom settings (See P41)
- If the POWER button is pressed and held when the power is off, the meter will turn ON for about 1 minute, and then turn OFF automatically. (Battery capacity can be saved even if the POWER button is pressed during transport.)

5 Basic Operation

5-1. Basic Operation Flowchart

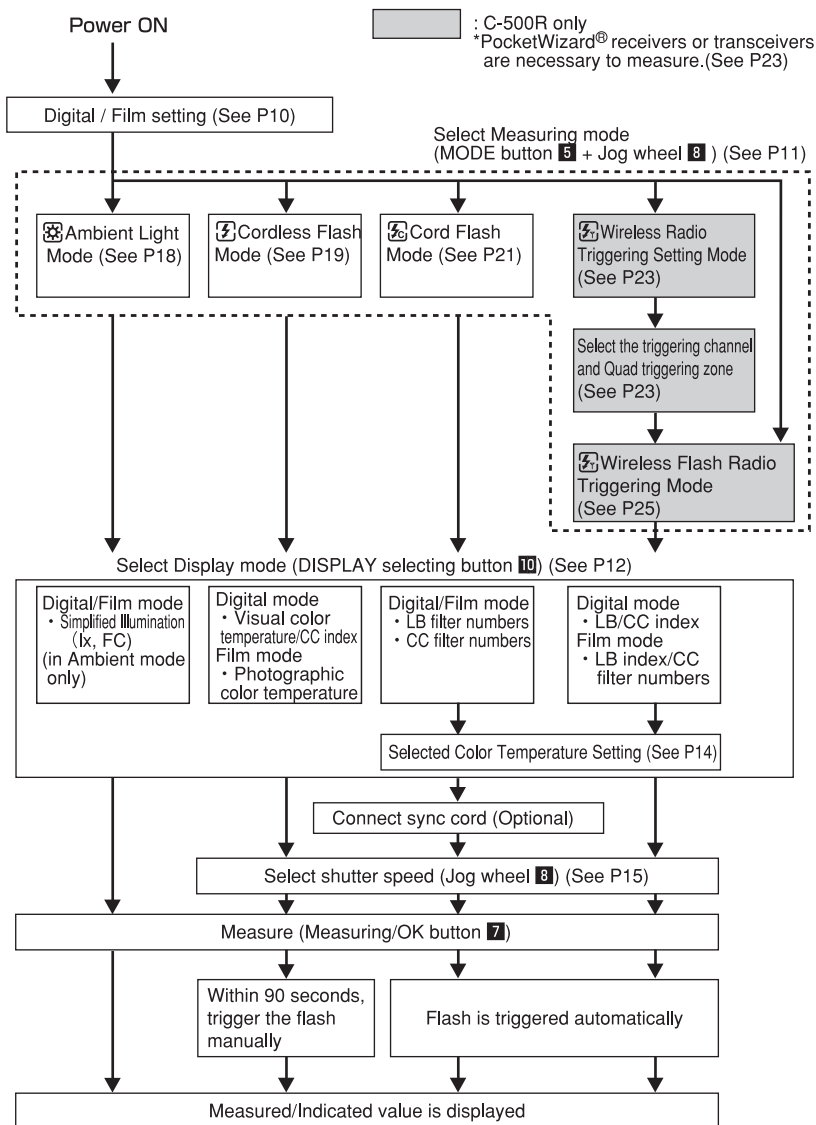

5-2. Digital / Film Settings

Depending on what type of camera is being used, select "Digital" or "Film" mode.

- 1) Press the MENU button **6** to enter the Main Menu. (Shown on the dot matrix display)
- 2) Turn the Jog wheel to display "DIGI/FILM".
- 3) Press the Measure/OK button **7** to select the DIGI/FILM setting. The **DIGITAL** or **FILM** icon will blink.
- 4) Turn the Jog wheel **8** to select either **DIGITAL** or **FILM**.
- 5) Press the Measuring/OK button **7** to save the setting. (You will return to the Main Menu.)
- 6) Press either the Memory (Δ)/BACK button **12**, or the MENU button **6** to return to the measurement screen.

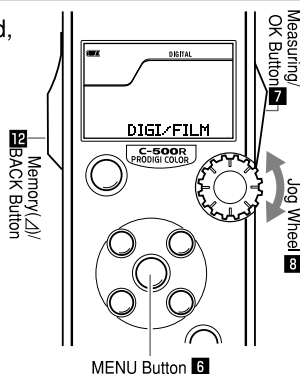

Main Menu screen

Sub-menu selection screen

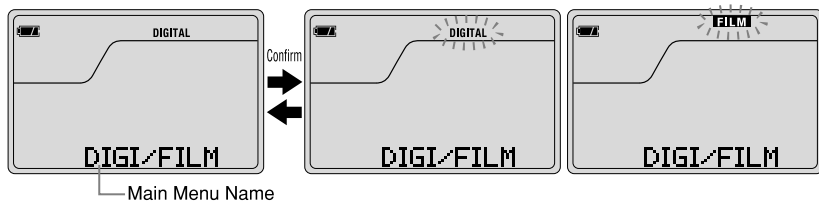

! Note

- If "Digital" is selected, settings based on digital camera characteristics (visual color temperature) are displayed; if "Film" is selected, settings based on film camera characteristics (photographic color temperature) are displayed.
- Please note that color reproduction will be inaccurate if "Digital" is selected when using a film camera, or vice versa.

5-3. Setting the Measuring Mode

Select the correct measuring mode for the type of light source to be measured.

While pressing the MODE button **5**, turn the Jog wheel **8** to select the measuring mode to be used.

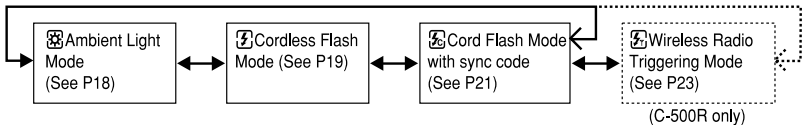
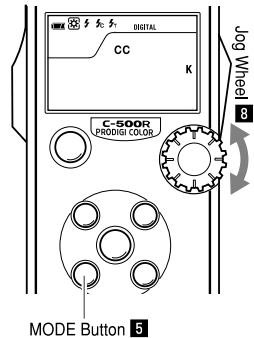

! Note

- If you change measuring mode settings, the measurement data will be erased.

Reference

- “Ambient light” includes continuous light sources such as natural light (sunlight), tungsten lamps or fluorescent lights.
- “Flash light” includes brief and intense burst of light sources such as electronic flash units or flash bulbs.

5-4. Setting the Display Mode

The C-500R/C-500 has four different display modes: Color temperature, LB index and CC index, LB filter number and CC filter number, and simplified illumination. Press the blue DISPLAY selecting button to select the desired display. The display mode will change each time the DISPLAY selecting button is pressed.

Reference

- Once a reading is made, the display modes can be changed with the readout describing that reading.

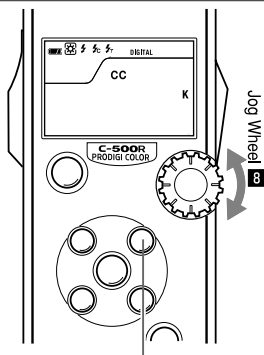

DISPLAY selecting Button 9

Display Modes when using “Digital” mode:

- Visual color temperature / CC index (displayed in K and CC)
Visual color temperature - - - This displays the actual color temp in K (Kelvin) of a scene based on the visual spectrum of the human eye or typical digital camera sensor. This measurement can be directly be entered into the color temp setting of your digital camera.

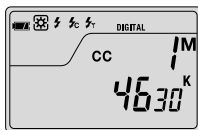

Visual Color Temperature + CC Index

CC index - - - The displayed CC (Color Correction Value) provides the necessary color correction, if the measure light source is overly bias towards a particular color. (1 CC index = 2.5 CC filter number)

- LB filter number / CC filter number (displayed as LB FILTER and CC FILTER)
Select this display when using Kodak Wratten or LEE filters to adjust the light source to the selected color temperature. (see P48). Fujifilm LBB/LBA filters can be selected in custom settings. (see P41).

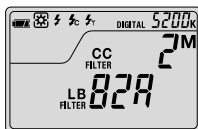

LB Filter No. + CC Filter No.
(Display in Kodak/LEE Filters)

Note

- Due to the characteristic of digital sensor, there might be a possibility that enough effect of filters are not obtained.

- LB index / CC index
LB index - - - Displayed in MK^{-1} (LB index increments is selectable in custom settings. See P41). Select this display mode when using filters compensated in LB Index values.
CC index - - - The displayed CC (Color Correction Value) provides the necessary color correction, if the measure light source is overly bias towards a particular color. (1 CC index = 2.5 CC filter number)

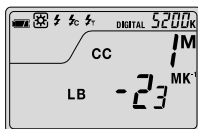

LB Index + CC Index

- **Simplified illuminance in ambient light mode**
Select this display when you measure the brightness of a continuous light source. The measurement will be displayed as lx (Lux) or FC (Foot-candle) as selected in the custom settings mode (See P 41)

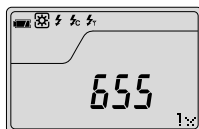

Illuminance Measurement
(Display in lux)

Note

- The simplified illuminance value displays the first 3 digits of the measured value, and is used as a reference for consistent light amount for photography, video or cinematography applications. It is not recommended to use for actual exposure values or calibration purposes.

Display Modes when using “Film” mode:

- **Photographic color temperature (displayed in K)**
This displays the actual color temp in K (Kelvin) of a scene based on the sensitivity of traditional film. The measured values are similar to other photographic color temperature meters.

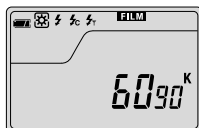

- **LB filter number / CC filter number (displayed as LB FILTER and CC FILTER)**
Select this display when using Kodak Wratten or LEE filters to adjust the light source to the selected color temperature. (see P48). Fujifilm LBB/LBA filters can be selected in custom settings. (see P41).

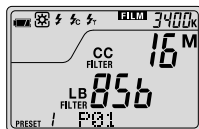

LB Filter No. + CC Filter No.
(Display in Kodak/LEE Filters)

- **LB index / CC filter number (displayed as LB and CC FILTER)**
LB index - - - Displayed in MK^{-1} (LB index increments can be selectable in custom settings. See P41). Select this display mode when using filters compensated in LB Index values.
CC filter number - - - Displayed in Kodak Wratten or LEE Color Compensation filters(see P48). Fujifilm CC filters can be selected in custom settings. (see P41).

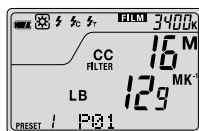

LB Index + CC Filter no.

- **Simplified illuminance in ambient light mode**
Select this display when you measure the brightness of a continuous light source. The measurement will be displayed as lx (Lux) or FC (Foot-candle) as selected in the custom settings mode (See P 41)

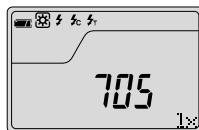

Illuminance Measurement
(Display in lux)

Note

● The simplified illumination values display the first 3 digits of the measurement values, and is used as a reference for consistent light amount in photography, video or cinematography applications. It is not recommended to use for actual exposure values or calibration purposes.

Reference

- 1 MK⁻¹ is equivalent to 1 Mired. (See P47)
- The unit of "MK⁻¹" is now used based on the International System of Units (SI) The latest unit is adopted to Prodigy Color C-500R/500.

5-5. Setting the Selected Color Temperature

A target color temperature (Kelvin number) can be set according to your color balancing needs. After setting, indicated value for either LB/CC filter number display or LB/CC index display mode will display the filtration needed to achieve the target color balance. The selected color temperature is displayed in the upper right hand corner of the LCD screen.

Reference

- The selected color temperature will not be displayed and cannot be changed if the display mode is showing the measured color temperature or simplified illuminance values.

While pressing the SET K button **10**, turn the Jog wheel **8** to set the selected color temperature.

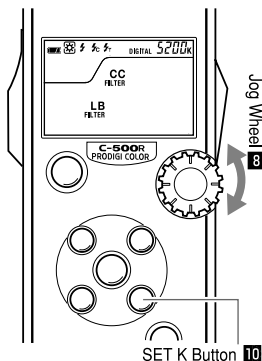

Measurement screen

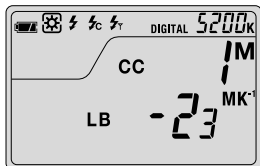

LB Index + CC index

Reference

Digital mode

- Set the meter to the same color temperature, that was selected in your camera. Please note that many digital cameras reproduce color better at certain color temperature settings. If your work requires optimum color reproduction and high color fidelity, select the camera manufacturers recommended color temperature for best color reproduction. (Please refer to your digital camera's operating manual.)
- Depending on your preferences, you can set the color temperature from 2,500K~10,000K in steps of 100K. (10MK⁻¹ can be selectable in custom setting. See P41.)
- For convenience, use the preset white balance color compensation function for the digital camera's preset white balance (See P36)

Film mode

- Set the selected color temperature of the type of film you are using.
Daylight type: 5,500K
Tungsten Type-A: 3,400K
Tungsten Type-B: 3,200K
- Depending on your preferences, you can set the color temperature from 2,500K~10,000K in steps of 100K.

5-6. Setting the Shutter Speed (Flash Modes Only)

In flash mode, set the shutter speed before taking a flash measurement.
Lower speeds will include color from any ambient light.

Higher speeds will register more of the flash color.

Turn the Jog wheel **8** to select the shutter speed.

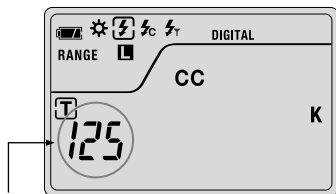

Shutter speed

"s" indicates the shutter speed measured in full seconds.

Ex.: 0.4s indicates a shutter speed of 0.4 seconds,
while 60 indicates a shutter speed of 1/60 of a second.

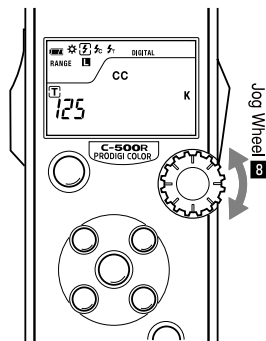

! Note

- Select a shutter speed range that will synchronize with your camera and flash system.
- If the shutter speed setting is changed in the meter, all previous measured data will be deleted.

Reference

- Shutter speeds can be changed in increments of Full, 1/2 and 1/3 steps in the custom settings. (See P41)
- Shutter speeds are selectable from 1 to 1/500 of a second. Special shutter speeds of 1/75, 1/80, 1/90, 1/100, 1/200 and 1/400 of a second are provided after you go pasted 1/500th of a second.

5-7. Selecting Preset White Balance/Color Compensation

There are 19 selectable Preset White Balance/Color Compensation values that you can preprogram to bias readings for specific digital camera or film characteristics or light sources and recall and apply the presets anytime you need them. You can input a simple alpha-numeric name for the preset you create to make it easier to identify. Preset values can not be set or changed while the meter is in color temperature or simplified illumination display modes.

! Note

- Make sure the Preset number to be used is selected in advance.

Reference

- For information on how to save presets, see P37.

- 1) While pressing the PRESET button **4**, turn the Jog wheel **8** to select the preset number. (Preset name will be displayed when it is entered in advance.)

The preset numbers cycle as follows: Preset number 1 ⇔ 2 ⇔ ... ⇔ 19 ⇔ "Blank (no preset)" ⇔ 1 ⇔ ..., with the values of each preset displayed.

Preset color temperature of a selected preset stored (Digital mode only)

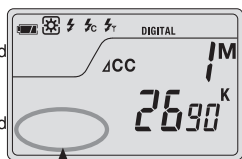
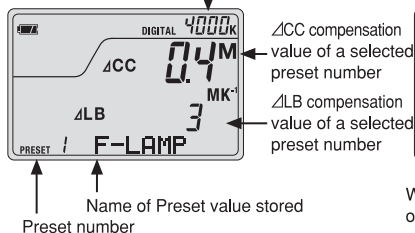

When the measured color temperature or simplified illuminance is displayed, on the LCD screen, stored preset names and location numbers are not shown.

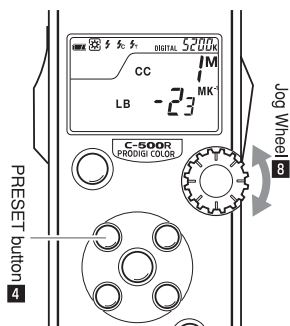

- 2) Release the PRESET button **4**.

Preset White Balance/ Color Correction values stored can be recalled and applied during color measurements. These stored Preset values adjust the meter readings to your preferences based on LB index and CC index/filter number units independently.

! Note

- Any preset color temperature saved as preset values will override the selected color temperature. (Digital mode only)

Reference

- In the measurement screen, while the PRESET button **4** is being pressed, the preset values are displayed.

6 Measurement

6-1. Measurement Method

Matching color temperature of multiple light sources:

When multiple light sources are being used, the color temperature of each light source must be matched (balanced). If light sources with unmatched (unbalanced) color temperature are used together in the same image inconsistent color will be present in the shadows and highlights.

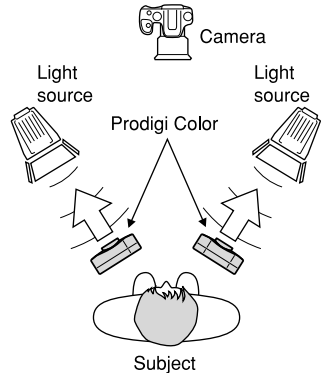

Matching color temperature for one light source and acquiring accurate camera to subject color reproduction.:

When the color temperature of multiple light sources are equal (or very close), the actual color temperature being illuminated needs to be measured for correct digital or film measurements and subsequently accurate color reproduction. Take a measurement by placing the color meter at the position of the subject with the light receptor facing towards the camera's lens axis.

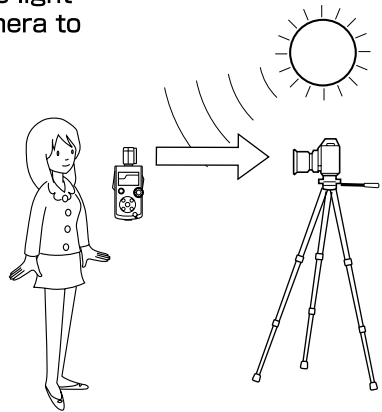

! Note

- It's common for a subject to be illuminated by reflected light from its surroundings, as well as from the main source of light. It is recommended that measurements be taken from the subject's position in these situations. If the main light source is more pronounced than the reflected light, measurement should be taken closer to the main light source with the light receptor pointed towards the light.
- Try to minimize the influence of the person taking the light measurements. (Do not obstruct the light sources. There will also be reflected light from the person's clothing, so do not allow this reflected light to enter the light receptor.)
- Because it may affect the precision of the measurements, be careful not to damage or dirty the light receptor (flat diffuser). If the light receptor becomes dirty, wipe it with a dry, soft cloth. Never use organic solvents such as thinner or benzene.

6-2. Measurement in Ambient Light Mode

Select Ambient Light Mode when taking measurements of continuous light source such as sunlight, tungsten lamps, or fluorescent lights.

- 1) Depending on what type of camera is being used, select "Digital" or "Film" mode. (Press the MENU button **6** and select the [DIGI/FILM] menu) (See P10)
- 2) While pressing the MODE button **5**, turn the Jog wheel **8**, to select the  Ambient Light Mode. (See P11)
- 3) Select the Display Mode.
Press the DISPLAY Selecting Button **9**, turn the Jog wheel to select the desired Display Mode. (See P12)
- 4) Set the selected color temperature. (See P14)

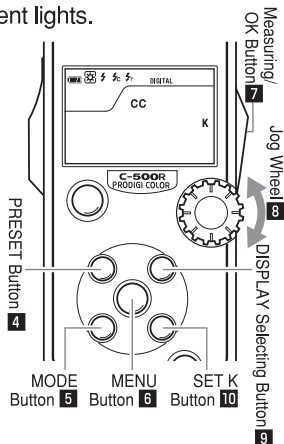

Reference

- If you are only using the selected color temperature display mode, you can omit this step.

- 5) If you need to compensate the indicated value on LCD screen, you can recall saved preset White Balance/Color Compensation and apply those settings to the indicated values. (While pressing the PRESET button **4** turn the Jog wheel **8** to select from the stored Preset numbers 1 through 19.) (See P16)

Reference

- Preset white balance/color compensation values must be saved in advance. (See P36)

- 6) Press the Measuring/OK button **7**. Measurement will be taken and the measured/indicated values will be displayed.
While the button is held, the meter measures continuously. When the button is released, the measurements will stop and the measured/indicated value at the time the button was released will be displayed.

Note

- If the light source illumination is too bright or not bright enough, or if color temperature is out of the measurement range, when the Measuring/OK button **7** is pressed, [D. Over] [U. Under] will blink to indicate that measurements cannot be made. In this case, adjust the brightness or color temperature. (See P30)

6-3. Measurement in Cordless Flash Mode

In Cordless Flash Mode, the meter will go into a standby mode (when the measure button is pressed) to wait for a burst of flash to measure. Cordless Flash Mode is preferable when the flash to subject distance is too far to use a sync cord or when wireless measuring is desired.

- 1) Depending on what type of camera is being used, select "Digital" or "Film" mode. (Press the MENU button **6** and select the [DIGI/FILM] menu) (See P10)
- 2) While pressing the MODE button **5**, turn the Jog wheel **8**, to select the  Cordless Flash Mode. (See P11)
- 3) Select the Display Mode.
Press the DISPLAY Selecting Button **9** to select the desired Display Mode. (See P12)
- 4) Set the selected color temperature. While pressing the SET K button **10**, turn the Jog wheel **8** to set the target color temperature. (See P14)

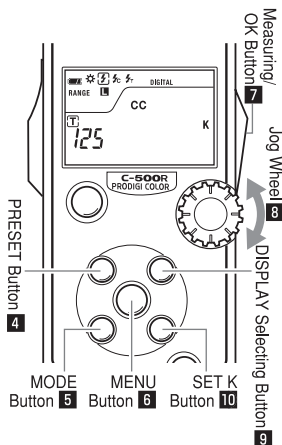

Reference

- If you are only using the selected color temperature display mode, you can omit this step.



- 5) Turn the Jog wheel **8** to set the shutter speed. (See P15)

! Note

- Select a shutter speed range that will synchronize with your camera and flash system.

Reference

- Preset white balance/color compensation values must be saved in advance. (See P36)

- 6) Press the Measuring/OK button **7**. The  icon will blink for 90 seconds and the meter will enter the measurement standby mode.
- 7) While the  icon is blinking, manually trigger the flash. A measurement will be taken and the measured/indicated values will be displayed.

! Note

- If the flash output power is too weak compared to the surrounding light, the meter may not detect the flash output. In this case, use the "Cord Flash Mode" (See P21).
- Pulsed light sources such as fluorescent lights or special lighting could cause the meter to take cordless flash measurements (in rare cases). The resulting reading will be incorrect. In these situations it is recommended to take a measurement in "Cord Flash Mode" with a sync cord attached to the meter and flash. (See P21).
- If there is a sudden, bright change in lighting intensity, the meter may mistakenly take a measurement. To avoid this, use the "Cord Flash Mode" (See P21).
- Because the light radiated from a flash bulb gradually builds, the meter will not detect the light when used in Cordless Flash Mode. Be sure to use the "Cord Flash Mode" (See P21) in this case.

Reference

- When using the meter in Cordless Flash Mode, it is possible to mount the meter to a light stand, tripod or similar support using the 1/4-20 female threads located on the bottom of the meter.
- If the light source illumination is too bright or not bright enough, or if color temperature is out of the measurement range, when the Measuring/OK button **7** is pressed, [**Q**, *Over*] or [**L**, *Under*] will blink to indicate that measurements cannot be made. In this case, adjust the brightness or color temperature, or switch the flash measurement range (See P28)
- If you need to compensate the indicated value on LCD screen, you can recall saved preset White Balance/Color Compensation and apply those settings to the indicated values.

6-4. Measurement in Cord Flash Mode

In the Cord Flash Mode, the meter and flash unit are connected with a Sync Cord (optional accessory). The Cord Flash mode is preferable when lighting conditions prevent the use of cordless measurements or when certain types of equipment requires a physical sync connection.

- 1) Depending on what type of camera is being used, select "Digital" or "Film" mode (Press the MENU button **6** and select the [DIGI/FILM] menu) (See P10)
- 2) While pressing the MODE button **5**, turn the Jog wheel **8** to select the  Cord Flash Mode. (See P11)
- 3) Select the Display Mode. Press the DISPLAY Selecting Button **9**, to select the desired Display Mode. (See P12)
- 4) Set the selected color temperature. While pressing the SET K button **10**, turn the Jog wheel **8** to set the target color temperature (See P14)

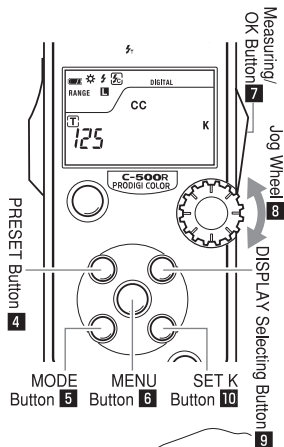

Reference

- If you are only using the selected color temperature display mode, you can omit this step.

- 5) Turn the Jog wheel **8** to set the shutter speed. (See P15)

! Note

- Select a shutter speed range that will synchronize with your camera and flash system.

- 6) Connect the flash sync cord (optional) to the meter's sync terminal **11**.

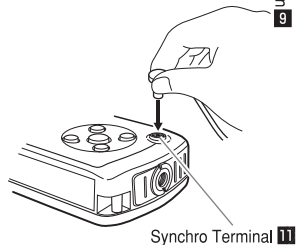

- 7) Press the Measuring/OK button **7**. The flash will be triggered and the measured/indicated values will be displayed.

Warning

- Infants or toddlers may accidentally swallow the Sync terminal cap, so please place it in a location out of their reach. There is a danger of suffocation.

Caution

- Do not handle this product with wet hands, or leave it in the rain or in a location where it may come in contact with water or moisture. If this product comes in contact with water while it is connected to a flash unit (in Cord Flash mode with a Sync Cord) there is a danger of electric shock. This may also result in damage to the meter.

Note

- Depending on the flash equipment used, the flash may be triggered when the sync cord is connected to the meter or when the meter is turned on.
- If the triggering voltage of the flash used is extremely low, the flash may not trigger. In these cases, use either Cordless Flash Mode (See P19) or Wireless Radio Triggering Mode (C-500R only) to take measurements. (See P23)
- When measuring flash bulbs, make sure the shutter sync speed is set to the proper synchronization range of your camera.

Reference

- If the light source illumination is too bright or not bright enough, or if color temperature is out of the measurement range, when the Measuring/OK button **7** is pressed, [**Q**, **Over**] or [**L**, **Under**] will blink to indicate that measurements cannot be performed. In this case, adjust the brightness or color temperature, or switch the flash measurement range (See P28).
- If you need to compensate the indicated value on LCD screen, you can recall saved preset White Balance/Color Compensation and apply those settings to the indicated values. (See P16)

6-5. Measurement in Wireless Radio Triggering Mode (C-500R Only)

The C-500R (only) incorporates a built-in radio transmitter that is compatible with the PocketWizard® wireless radio system. When a PocketWizard® wireless radio (Receiver or Transceiver) is connected to one or more electronic flash units, it's possible for the meter to trigger and measure the color temperature of the flash simultaneously by pressing the Measuring/OK button.

Before using the Wireless Radio Triggering Mode, it is necessary to set the meter and the PocketWizard® (Receiver or Transceiver) the same radio channel (and Quad Triggering Zone).

Reference

- If you have already set the channel to be used, proceed to the next section "6-5-2 Measurement in Wireless Radio Triggering Mode".

6-5-1. Selecting Radio Triggering Channel and Quad-Triggering Zone Mode

Once you have selected Wireless Radio Triggering Mode, it is necessary to select a radio triggering channel to be used. There are up to 32 channels available for wireless radio triggering. Channels 1 - 16 are single channels. Channels 17 - 32 contain selectable Quad triggering zone (A, B, C, or D). Each Quad triggering zone can be set to trigger independently from the others. Depending on which Quad triggering zone is selected, it is possible to trigger one or more Quad triggering zone at the same time. Up to four zones can be triggered simultaneously.

LPA Design, manufacturers of the PocketWizard® wireless system currently offer two systems.

The PocketWizard Plus II (4-channel radio) and the MultiMAX (32-channel radio).

- 1) While pressing the MODE button **5**, turn the Jog wheel **8** to select to  Wireless Radio Triggering Setting Mode. (See P11)
The [CHSetting] is displayed in the dot matrix display of the LCD screen, showing the currently-set channel number.
- 2) Select the channel (CH) number you wish to set.
※For channels No.1~16:
 1. Turn the Jog wheel **8** to select the channel No. and press the Measuring/OK button **7** to confirm. The Wireless Radio Triggering Mode measurement screen will be displayed.
 2. Proceed to the next section "6-5-2 Measurement in Wireless Radio Triggering Mode".

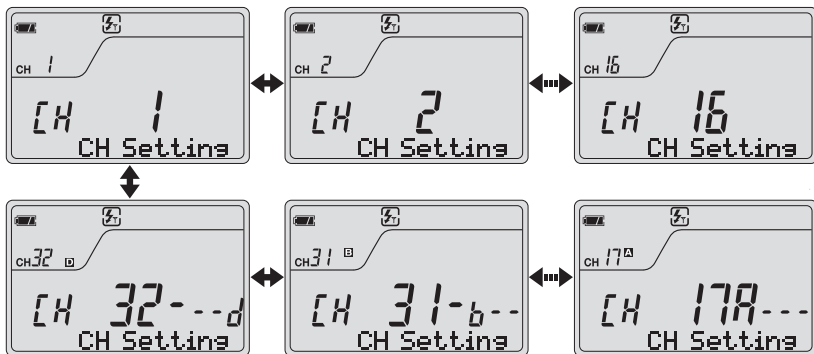

※For channels No. 17~32:

- Turn the Jog wheel **8** to select the channel number. (see above illustrations) The currently-set quad-triggering zone (A, B, C, or D) are displayed.
Each of the following buttons corresponds to a quad-triggering zone: the PRESET button **4** to "A", the MODE button **5** to "B", the DISPLAY Selecting button **9** to "C", and the SET K Button **10** to "D".
- Press the button corresponding to the quad-triggering zone you wish to select.
For example, if you wish to select quad-triggering zone A, when you press the PRESET button **4**, the display will toggle between "A" (selected) and "-" (unselected). In the diagram at right, A, B, and D are not.
- Press the Measuring/OK button **7** to confirm the selected quad-triggering zone.
The Wireless Radio Triggering Mode (measurement screen) will be displayed.
- Proceed to the next section "6-5-2 Measurement in Wireless Radio Triggering Mode".

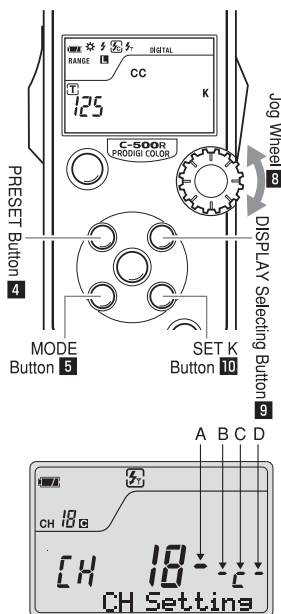

6-5-2. Measurement in Wireless Radio Triggering Mode

While pressing the MODE button **5**, turn the Jog wheel **8** to select to  Wireless Radio Triggering Mode. (See P11)

The currently-set channel number (and/or quad-triggering zone) will be displayed.

! Note

- If you wish to change the channel number, by double-clicking the MODE button **5** you can return to the channels selection screen.

Wireless Radio Triggering Mode measurement screen

The set channel / quad-triggering zone is displayed.

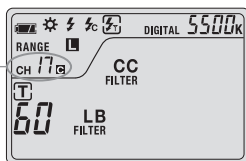

- 1) Depending on what type of camera is being used, select "Digital" or "Film" mode. (See P10)
- 2) Select the Display Mode.
Press the DISPLAY Selecting Button **9** to select the desired Display Mode. (See P12)
- 3) Set the selected color temperature. While pressing the SET K button **10**, turn the Jog wheel **8** to set the target color temperature. (See P14)

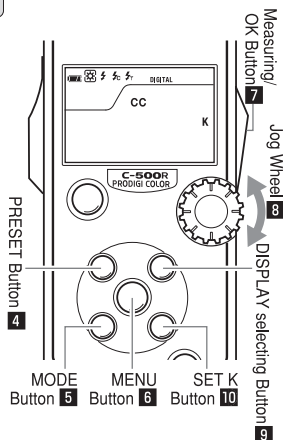

Reference

- If you are only using the selected color temperature display mode, you can omit this step.

- 4) Turn the Jog wheel **8** to set the shutter speed. (See P15)

! Note

- Select a shutter speed range that will synchronize with your camera and flash system.

- 5) Confirm that the channel (or quad-triggering zone) numbers are the same for the meter and the PocketWizard receiver.
- 6) Press the Measuring/OK button **7**. The flash will be triggered and a measurement will be displayed.

! Note

- If the flash output power is too weak compared to the surrounding light, the meter may not detect the flash output. In this case, use the "Cord Flash Mode" (See P21).
- Pulsed light sources such as fluorescent lights or special lighting could cause the meter to take cordless flash measurements (in rare cases). The resulting reading will be incorrect. In these situations it is recommended to take a measurement in "Cord Flash Mode" with a sync cord attached to the meter and flash. (See P21)
- Because the light radiated from a flash bulb gradually builds, the meter will not detect the light when used in Cordless Flash Mode. Be sure to use the "Cord Flash Mode" (See P21) in this case.

Reference

- If the light source illumination is too bright or not bright enough, or if color temperature is out of the measurement range, when the Measuring/OK button **7** is pressed, [L, 0.000] or [L, 10000] will blink to indicate that measurements cannot be made. In this case, adjust the brightness or color temperature, or switch the flash measurement range. (See P28)
- If you need to compensate the indicated value on LCD screen, you can recall saved preset White Balance/Color Compensation and apply those settings to the indicated values. (See P16)

Reference

- Please refer to the PocketWizard Receiver or Transceiver instruction manual for the proper use.
- Maximum distance of the wireless radio triggering system can vary depending on the placement of the remote Receiver or Transceiver, direction of the radio's antenna, distance from a large body of water or concrete wall and other possible cause of radio failure.

1. Confirm the range between the C-500R and Receiver or Transceiver.
2. Place the C-500R and Receiver or Transceiver away from large metal objects, concrete, objects, large moisture content (both people and trees fall into the category) and so forth.
3. Secure the radio Receiver or Transceiver in place by using Velcro tape or a 1/4-20 mounting screw. Be sure that the entire length of the Receiver or Transceiver antenna is higher than the flash pack. Avoid contact between the Receiver or Transceiver antenna and metal objects at all times.
4. Depending on the location, there may be cases when the Receiver or Transceiver is incapable of receiving any radio signals whatsoever. There are several possible causes for this such as radio signals reflected off of nearby objects. This can generally be resolved by shifting the C-500R or the Receiver or Transceiver slightly in one direction or another. In addition, confirm that the Receiver or Transceiver is not placed behind objects that readily absorb or deflect radio signals such as concrete, metal, low hills, etc.

! Note

- The Wireless flash triggering system may be used only in countries where a permit for the control frequency has been issued by the government office in charge. There are several kinds of frequencies in the world, and we recommend you check if the C-500R and Receiver(s) or Transceiver(s) are compatible with each other.

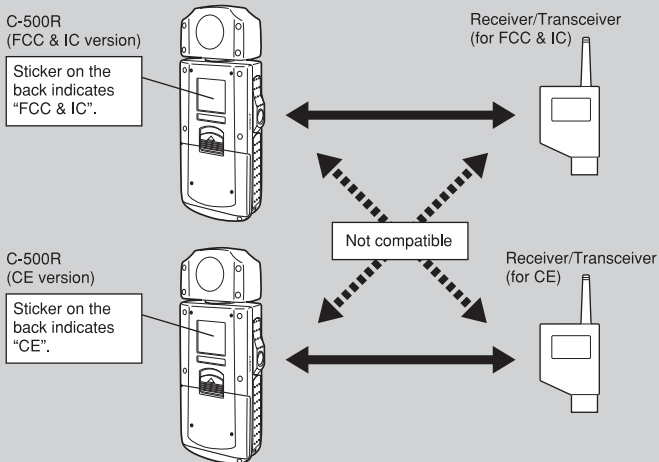

- There are no serviceable parts inside the transmitter built in the meter.

6-6. Selecting Flash Measurement Range (Flash Modes Only)

Depending on the strength of the flash output power, you can toggle between ranges (**H**/**L**). The currently-set range is displayed in the top left of the screen.

- 1) Press the MENU button **6** to enter the Main Menu. (The menu name is displayed in the dot matrix display)
- 2) Turn the Jog wheel **8** to select [SET RANGE].
- 3) Press the Measuring/OK button **7**. The currently-set range (**H**/**L**) will blink.
- 4) Turn the Jog wheel **8** to select the desired range (**H**/**L**).
- 5) Press the Measuring/OK button **7**. The set range (**H**/**L**) will stop blinking.
- 6) Press the Memory (Δ)/Back button **12** or the MENU button **6** to return to the measurement screen.

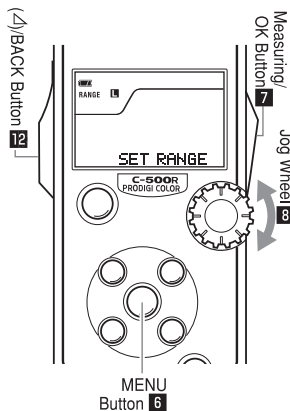

H : Select this when the flash output power is high. When measuring, if the flash output power is too low, [**L**, *Under*] will blink on the display. In this case, switch the range from H to L.

L : Select this when the flash output power is low. When measuring, if the flash output power is too high, [**H**, *Over*] will blink on the display. In this case, switch the range from L to H.

Switch range from H to L

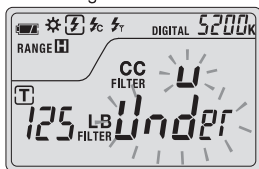

Switch range from L to H

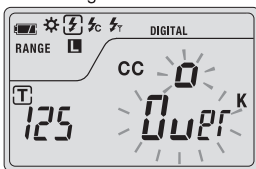

[Range Settings and Aperture Values]

Below are the recommended aperture values for the H or L range.
(When ISO is set to 100)

F No. 160~90s

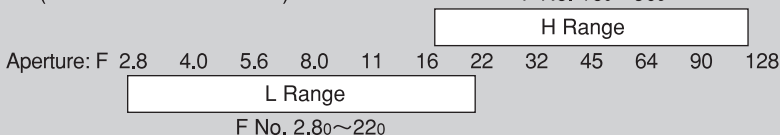

6-7. Out of Display Range / Measurement Range

6-7-1. Out of Display Range

When [**0**, **Over**] appears on the LCD screen:

If the indicated values are higher than the maximum display range, [**0**, **Over**] will appear.

If you turn the Jog wheel **8** and change the shutter speed to the higher-speed end of the range with which it can synchronize with your camera, or lower the flash output power, and then take another measurement, the indicated values will be able to be displayed.

When [**U**, **Under**] appears on the LCD screen:

If the indicated values are lower than the minimum display range, [**U**, **Under**] will appear.

If you turn the Jog wheel **8** and change the shutter speed to the lower-speed end of the range with which it can synchronize with your camera, or raise the flash output power, and then take another measurement, the indicated values will be able to be displayed.

Higher than display range

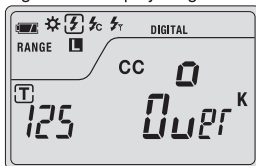

Lower than display range

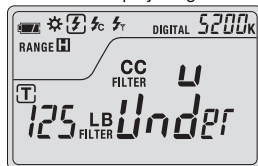

Display range:

Color Temperature(Digital/Film): 2,300 to 20,000 K

LB filter numbers

(Kodak Wratten/LEE):80A+80D to 85B+81EF (40 types in all)

(LBA/LBB): B20+B16 to A20+A16 (57 types in all)

CC filter numbers: 200G to 200M

LB index: -50 to +50daMK-1(-500~+500MK-1)

CC index: 80G to 80M (1daMK-1 steps)

Simplified illuminance: lx:2.5 to 610,000lx

FC:0.23~56,500FC

6-7-2. Out of Measurement Range

If [0, 0000] blinks on the display:

When [0, 0000] blinks even after setting the flash measurement range to [1], measurement cannot be taken. In this case, adjust the flash output power or move away from the light source and take another measurement.

If [U, 0000] blinks on the display:

When [U, 0000] blinks even after setting the flash measurement range to [2], measurement cannot be taken. In this case, adjust the flash output power or move closer to the light source and take another measurement.

Display of Over measurement range

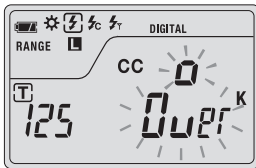

Display of under measurement range

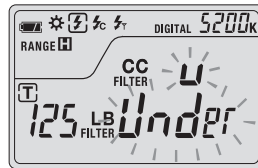

Measurement Range(for ISO 100):

Brightness in measurement of color temperature:

Ambient light: EV3 (20lx) to EV16.3 (200,000lx)

Flash light L range: f2.8₀ to f22₉

Flash light H range: f16₀ to f90₉

Simplified illuminance: lx:2.5 to 610,000lx

FC:0.23 to 56,500FC

7 Other Functions

7-1. Memory (Δ) Function

This function offers an accurate way to measure the uniformity of the multiple light sources.

After taking an initial measurement to establish a standard color temperature value (ex. main light), it is possible to compare the differences between the standard measured value and the new measured value (ex. color temp value shift from main light to fill light). This Memory(Δ) function can be used in every display mode.

- 1) Measure the area of the light source that you want to use as a standard by pressing the Measuring/OK button **7**.
- 2) Press the Memory (Δ)/BACK button **12** to save the standard values in memory.

In the lower left of the screen, the letter “M” will blink to indicate that the meter is in Memory mode.

- 3) At the location to be used for comparison, press and hold the Measuring/OK button **7**.

While the Measuring/OK button **7** is being pressed, the difference between the standard measurement and comparison measured values will be displayed.

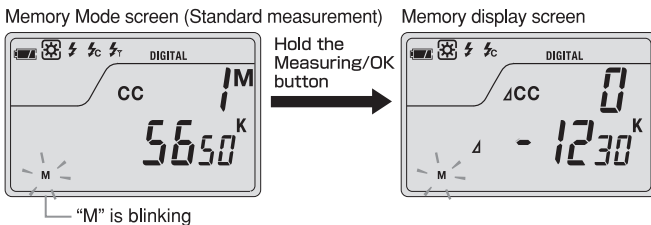
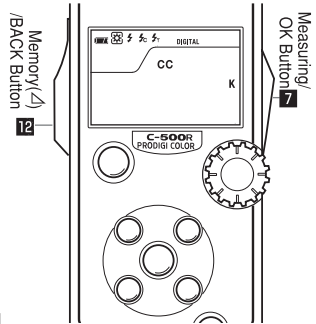

Reference

- If the Measuring/OK button **7** is released, the value saved in memory in step 2) will be displayed.

- 4) To clear the Memory (Δ) mode, Press the Memory (Δ)/BACK button **12** again. The letter “M” disappears and the display returns to the normal measurement screen.

7-2. Jog Wheel Lock / Release

To avoid accidentally changing the shutter speed settings with the Jog wheel, the Jog wheel can be locked.

Setting the Lock:

Press the PRESET button **4** and the MODE button **5** at the same time. [LOC] will be displayed, and the Jog wheel **8** will be locked. (Once the Jog Wheel **8** is locked, all settings and measured values can not be accidentally changed). However, if the Measuring/OK Button **7** is pressed, a new measurement value will be displayed. (Settings will not be changed.)

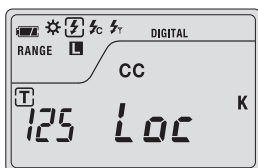
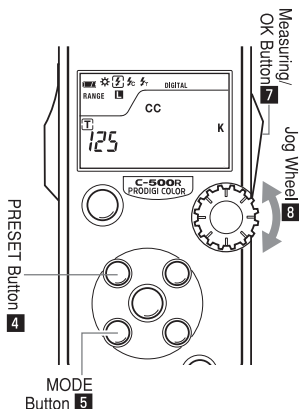

Reference

- If the Jog wheel **8** is turned, [LOC] will be displayed momentarily to indicate that the Jog wheel is locked.

Releasing the Lock:

Press the PRESET button **4** and the MODE button **5** at the same time again. [OFF] will be displayed, and the Jog wheel **8** lock will be

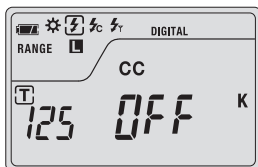

Reference

- Even if the power is ON/OFF, the Jog Wheel will remain locked until the Jog Wheel is unlocked.

8 Menu Settings

In Menu Mode, various measurement conditions can be set.

8-1. Menu Reference

A menu reference is shown below.

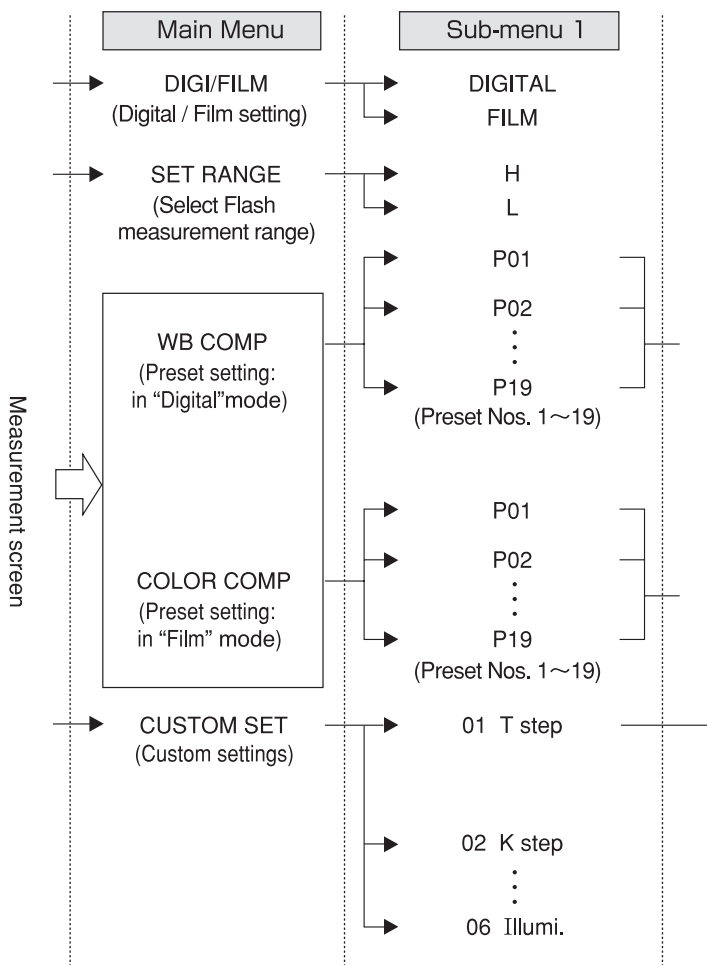

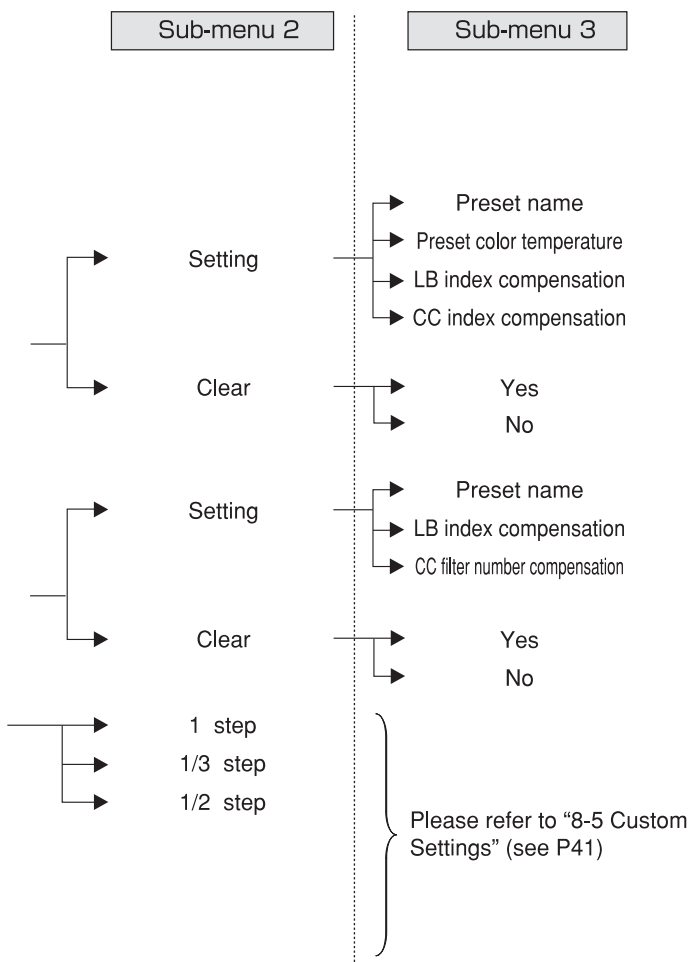

Basic Menu Mode Operation

To enter Menu Mode	In the measurement screen, press the MENU button 6 . The main menu is shown in the dot matrix display.
To select menus / sub-menus	Turn the Jog wheel 8 to display the desired menu. If the Measuring/OK button 7 is pressed, that menu will be selected. If there are sub-menus, turn the Jog wheel 8 to display the desired sub-menu in the same way. If the Measuring/OK button 7 is pressed, that sub-menu will be selected.
To return to the previous screen	Press the Memory (Δ)/BACK button 12 . The settings will be confirmed and the display will return to the previous screen.
To return to the measurement screen	Press the MENU button 6 . The settings will be confirmed and the display will return to the measurement screen.

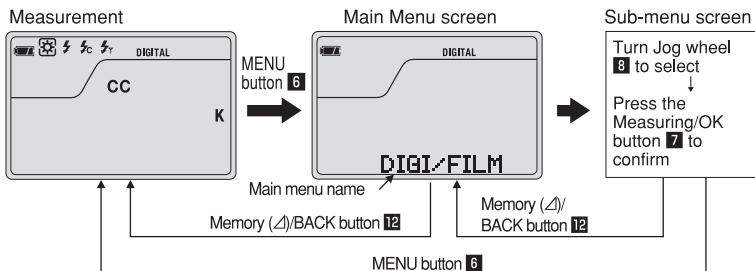

8-2. Digital / Film Settings

Depending on the type of camera to be used, select either "Digital" or "Film" mode in the main menu of [DIGI/FILM].

Please refer to "5-2. Digital / Film Settings" (See P10).

8-3. Selecting Flash Measurement Range

Toggle the range (**H**/**L**) corresponding to your flash output power by selecting [SET RANGE] in the Main Menu.

Please refer to "6-6. Selecting Flash Measurement Range (Flash Modes Only)" (See P28).

8-4. Preset White Balance/Color Compensation

You can set a preset color temperature (digital only), LB index compensation, or CC index/filter number compensation in Presets No. 1 to 19. During measurement, you can recall and use the values saved in a Preset Number.

Also, each Preset Number can be given a name of up to 8 characters.

The meter has been calibrated to Sekonic standards, however if the indicated compensating values do not yield the desired or expected color reproduction, than it will be necessary to modify the filter compensation values.

In this case, if you save the compensation values in memory as a preset number and then take measurements, you can display results with the compensated values.

Also, because you can set your digital camera's preset color temperature as a stored preset value, even if you do not input a selected color temperature, you can recall and use your preset color temperature when taking measurements.

Digital

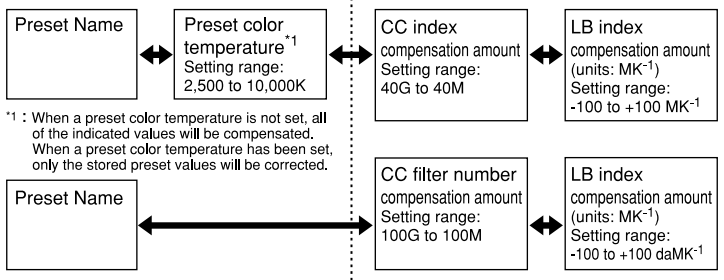

! Note

- When making compensation, please be sure to match them to your own requirements based on sufficient testing of your digital cameras or type of used.
- Compensations that are saved as presets will only be applied to LB/CC indexes or LB/CC filter numbers measurements. Color temperature (K) and illuminance (lx, FC) will not be compensated.

8-4-1. Setting and Saving Preset Data

Set and save preset data by selecting [WB COMP] (in “Digital” mode) or [COLOR COMP] (in “Film” mode) from the Main Menu.

- 1) Press the MENU button **6** to enter the Main Menu. (The menu name is shown in the dot matrix display.)
- 2) Turn the Jog wheel **8** to select [WB COMP] (in “Digital” mode) or [COLOR COMP] (in “Film” mode).
- 3) Press the Measuring/OK button **7** to confirm. The preset number and preset name are displayed in the dot matrix display. (If no name has been given to the preset, P01 to P19) will be displayed.)
- 4) Turn the Jog wheel **8** to select the desired preset number.
- 5) Press the Measuring/OK button **7** to confirm. ([Setting] will be displayed.)
- 6) Turn the Jog wheel **8** to select [Setting], and press the Measuring/OK button **7**.

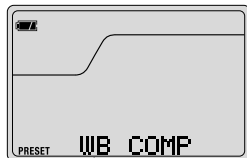
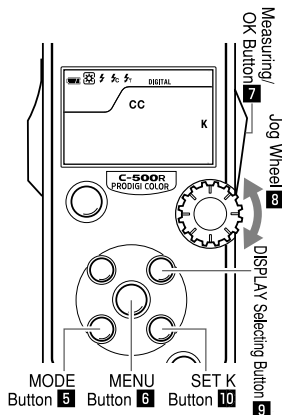

For “FILM”, COLOR COMP appears

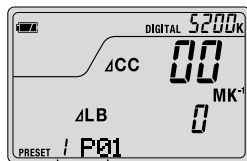

Preset No. Preset Name



7) The cursor will be blinking in the first character space of the preset name, and you can name the preset (maximum of 8 characters). (You can skip this step if you do not want to name the preset. Press the Measuring/OK button **7** and proceed to step 8.)

1. Turn the Jog wheel **8** to select the desired character.

- Usable characters are upper- and lower-case letters, numbers, blank spaces, and the symbols: "@", "- (hyphen)", ",", "(comma)" and ".(period)".
- Press the DISPLAY Selecting button **9** to toggle between upper- and lower-case letters.

2. Press the SET K Button **10** to move the cursor one space right. (Press the MODE button **5** to move the cursor one space left.)

3. Repeat steps 1 and 2 to continue entering characters.

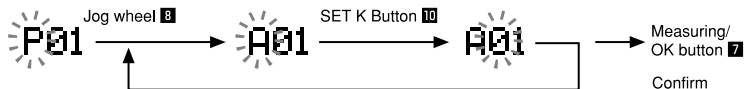

4. Press the Measuring/OK button **7** to confirm the preset name.

in "Digital" mode: The preset color temperature value will start to blink. (Proceed to the next step of 6.)

in "Film" mode: The CC filter number value will start to blink. (Proceed to step of 7.)

8) The preset color temperature value will be blinking. (in "Digital" mode only). Turn the Jog wheel **8** to select the preset color temperature and press the Measuring/OK button **7** to confirm. (The CC index value will start to blink.)

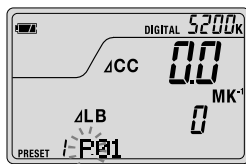

Blinking cursor

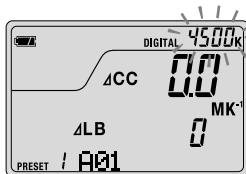
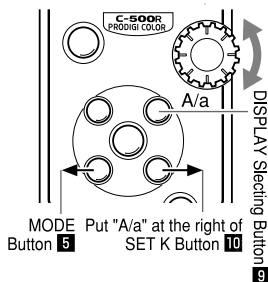

Note

- When a preset color temperature is not set, all of the indicated values will be compensated. When a preset color temperature has been set, only the stored preset values will be corrected.

- 9) The CC index/filter number value will be blinking. Turn the Jog wheel **8** to select the compensation value and press the Measuring/OK button **7** to confirm. (The LB index value will start to blink.)

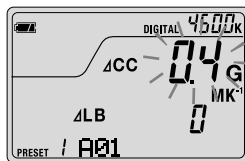

Reference

- 1 of CC index (in "Digital" mode) is equivalent to 2.5 CC filter number. (See P12)

- 10) The LB index value will be blinking. Turn the Jog wheel **8** to select the compensation value and press the Measuring/OK button **7** to confirm. (You will now return to the preset name input with the cursor blinking in the first character position.)

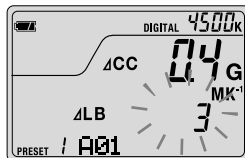

- 11) Preset settings have been completed. To return to the measurement screen press the MENU button **6**, or to return to the previous screen press the Memory (Δ)/BACK button **12**.

Reference

In "Digital" mode

- Set the stored preset values based on your digital camera's manufacturer's recommended color temperature setting for better color reproduction or color fidelity.
- Refer to your digital camera's instruction manual for color temperature values.
- For your convenience, preset white balance color temperatures are listed below. (See P36)

Reference (Color temperature of camera's preset white balance mode)

Sunlight:	5,200K ~ 5,400K
Shade:	7,000K ~ 8,000K
Cloudy sky:	Approximately 6,000K
Incandescent light bulb:	2,800K ~ 3,200K
White fluorescent light:	4,000K ~ 4,200K
Flash light:	5,400K ~ 6,000K

*The color temperature of preset white balance depends on each digital cameras/manufacturers. Refer to the instruction manual for the digital camera being used.

8-4-2. Clearing Preset Data

You can clear a preset name, preset color temperature (in "Digital" mode only), LB or CC index/filter number compensation values, in each preset number all at once.

- 1) Press the MENU button **6** to enter the Main Menu. (The menu name is shown in the dot matrix display.)
- 2) Turn the Jog wheel **8** to select [WB COMP] (in "Digital" mode) or [COLOR COMP] (in "Film" mode).
- 3) Press the Measuring/OK button **7**.
The preset number and preset name are displayed in the dot matrix display. (If no name has been given to the preset, P01 (to P19) will be displayed.)
- 4) Turn the Jog wheel **8** to select the preset number you wish to clear.
- 5) Press the Measuring/OK button **7**.
([Clear] will be displayed.)

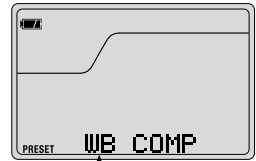

In "Film" mode,
COLOR COMP appears

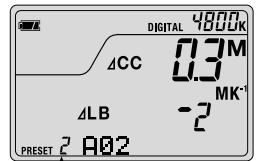

preset No.

- 6) Turn the Jog wheel **8** to select [Clear], and press the Measuring/OK button **7** to confirm.
- 7) Turn the Jog wheel **8** to select [Clear?: Yes] and press the Measuring/OK button **7** to confirm.
The selected preset number's value will be cleared. (If you wish to cancel the clear procedure, select [Clear?:No] and press the Measuring/OK button **7** to confirm.)

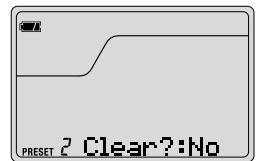
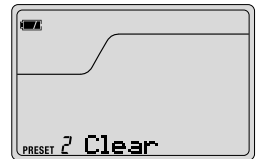

- 8) To return to the measurement screen press the MENU button **6**, or to return to the previous screen press the Memory (Δ)/BACK button **12**.



8-5. Custom Settings

The following custom settings are available in Menu mode. You can change them to suit your own individual preferences.

- [T step] (shutter speed step):
Select the shutter speed from [1 step], [1/3 step], or [1/2 step].
- [K step] (Selected color temperature step):
Toggle the selected/preset color temperature between 100K step and 10MK⁻¹ step by turning the Jog wheel.
- [LB step] (LB index display step):
Toggle the LB index step between 1 MK⁻¹ step, 1daMK⁻¹ (no decimal point) step, and 1daMK⁻¹ (with decimal point) step by turning the Jog wheel.
- [LB filter] (LB filter number display):
Select the type of LB filter number (Kodak Wratten, /LEE or Fuji's LBA/LBB).
- [Auto off] (Automatic Power OFF Setting):
Select the time before the power automatically turns off if no operation is performed (20 min., 10 min., 5 min., None). When [None] is set, the automatic power OFF function is disabled.
- [Illumi.] (Simplified illuminance mode):
Select to display or not display the simplified illuminance between [None], "both lx and FC" or "lx or FC individually"
(lx=Lux, FC=Foot-Candle)

Custom Settings Reference

Sub menu 1		Sub menu 2			
Setting number	Custom setting name	Item name / number			
		0	1	2	3
01	T step (*1) (Shutter speed step)	1 step (1step)	1/3 step (1/3 step)	1/2 step (1/2 step)	-
02	K step (*2) (Selected/preset color temperature step)	100Kstep (100Kstep)	10MK ⁻¹ step (10MK ⁻¹ step)	-	-
03	LB step (*3) (LB index display step)	1MK ⁻¹ (1MK ⁻¹ step)	1daMK ⁻¹ (1daMK ⁻¹ step, no decimal point)	0.1daMK ⁻¹ (1daMK ⁻¹ step, with decimal point)	-
04	LB filter (LB filter number selection)	Wratten Kodak Wratten/LEE	LBA/LBB Fuji LBA/LBB		-
05	Auto off (Automatic power OFF setting)	20min (20 minutes)	10min (10 minutes)	5min (5 minutes)	None (Disable)
06	Illumi. (Simplified illuminance mode)	None (Not displayed)	lx + FC (both lx and FC)	lx (Only lux display)	FC (Only FC display)

Default settings are all set to "0 (zero)".

*1: Selectable shutter speeds (in seconds)

1 step (Default)	1, 1/2, 1/4, 1/8, 1/15, 1/30, 1/60, 1/125, 1/250, 1/500, 1/75, 1/80, 1/90, 1/100, 1/200, 1/400
1/3 step	1, 0.8, 0.6, 0.5, 0.4, 0.3, 1/4, 1/5, 1/6, 1/8, 1/10, 1/13, 1/15, 1/20, 1/25, 1/30, 1/40, 1/50, 1/60, 1/80, 1/100, 1/125, 1/160, 1/200, 1/250, 1/320, 1/400, 1/500, 1/75, 1/80, 1/90, 1/100, 1/200, 1/400
1/2 step	1, 0.7, 1/2, 1/3, 1/4, 1/6, 1/8, 1/10, 1/15, 1/20, 1/30, 1/45, 1/60, 1/90, 1/125, 1/180, 1/250, 1/350, 1/500, 1/75, 1/80, 1/90, 1/100, 1/200, 1/400

*2: Selectable selected/preset color temperature (in K)

100K step	2500, 2600, 2700, 2800, 2900, 3000, 3100, 3200, 3300, 3400, 3500, 3600, 3700, 3800, 3900, 4000, 4100, 4200, 4300, 4400, 4500, 4600, 4700, 4800, 4900, 5000, 5100, 5200, 5300, 5400, 5500, 5600, 5700, 5800, 5900, 6000, 6100, 6200, 6300, 6400, 6500, 6600, 6700, 6800, 6900, 7000, 7100, 7200, 7300, 7400, 7500, 7600, 7700, 7800, 7900, 8000, 8100, 8200, 8300, 8400, 8500, 8600, 8700, 8800, 8900, 9000, 9100, 9200, 9300, 9400, 9500, 9600, 9700, 9800, 9900, 10000
10MK ⁻¹ step	2500, 2550, 2650, 2700, 2800, 2850, 2950, 3000, 3100, 3200, 3300, 3400, 3600, 3700, 3800, 4000, 4200, 4300, 4500, 4800, 5000, 5300, 5600, 5900, 6300, 6700, 7100, 7700, 8300, 9100, 10000

*3: LB index display step

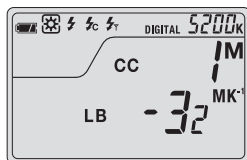

1MK⁻¹ (=1 Mired)

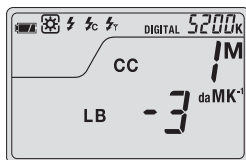

1daMK⁻¹ (rounded to the whole number)

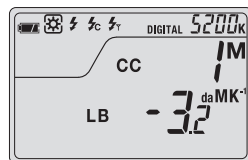

0.1daMK⁻¹

Reference

- 1 MK⁻¹ is equivalent to 1 Mired. (See P47)
- The unit of "MK⁻¹" is now used based on the International System of Units (SI) instead of traditional unit of "Mired". The latest unit is adopted to Prodigy Color C-500R/500.

[How to read the Custom Settings screen]

Shown during custom settings

Main Menu screen

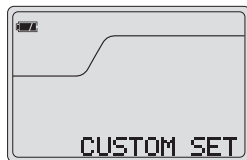

Custom settings main menu

Sub-menu 1 selection screen



Setting number
Custom setting name
item number

Sub-menu 2 selection screen

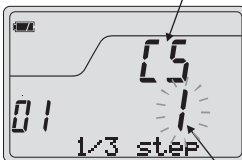

item name
item number (blinking)

As an example, this is how to set the T step (shutter speed step). Setting any other item follows the same procedure.

- 1) Press the MENU button **6** to enter the Main Menu. (The menu name is shown in the dot matrix display.)
- 2) Turn the Jog wheel **8** to select [CUSTOM SET].
- 3) Press the Measuring/OK button **7** to confirm.
- 4) Turn the Jog wheel **8** and select [T step] from the sub-menu1 ([T step]↔[K step]↔...↔[Illumi.])
The custom setting name [T step] is shown in the dot matrix display, and a number (0, 1, 2) being set to the current T step value is displayed above.
- 5) Press the Measuring/OK button **7**.
The current setting item number will blink. In the example, “0” is blinking and “1 step” is displayed.
- 6) Turn the Jog wheel **8** to select the desired item name and number, and press the Measuring/OK button **7** to confirm. (The display returns to step 3).
- 7) Repeat steps 3)~5) to set other items as desired.
- 8) Press the MENU button **6** to return to the measurement screen, or press the Contrast(Δ)/BACK button **12** to return to the previous screen.

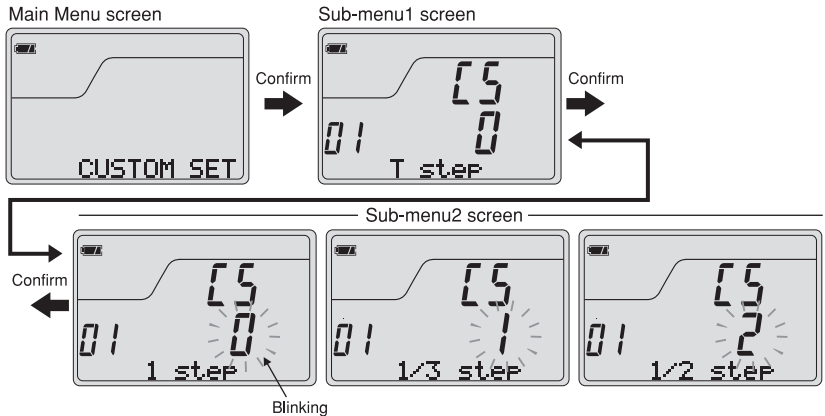

9 Optional Accessories

● Sync Cord

A convenient five-meter(=16.4 feet) long cord with three plugs, allowing you to connect and synchronize between a color meter, flash unit and camera, so there is no need to plug or unplug the cord during a shooting. Also, one terminal of the sync cord has a locking mechanism to ensure connection when used with a color meter.

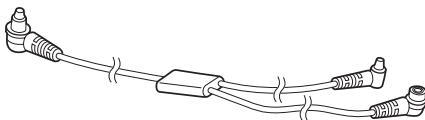

10 Specifications

Type	●Color meter with 4internal sensor for digital or film cameras	
Light receiving method	●Incident light	
Light receptor	●Flat diffuser (fixed type lumidisc)	
Light receptor element	●Silicon photo diode (4 sensors) with visible transmitting filter	
Measurement system	●Measuring mode	<ul style="list-style-type: none"> •Ambient light Ambient light mode •Flash light Cord flash mode with sync cord Cordless flash mode Wireless radio triggering mode(C-500R only)
	●Measurement type	<ul style="list-style-type: none"> •Digital Color temperature measurement based on approximation of color matching function (Visual color temperature) •Film Color temperature measurement based on approximation of film spectral characteristics (Photographic color temperature) •Simplified illuminance Illuminance measurement based on approximation of visibility characteristic
Display mode	●Display mode	<ul style="list-style-type: none"> •Digital Color temperature + CC index LB filter number + CC filter number LB index + CC index Color temperature LB filter number + CC filter number LB index + CC filter number •Simplified illuminance Ambient light: lux (lx), foot-candle (FC)
	•Film	
	•Simplified illuminance	
Measurement range (ISO100)	●Illuminance in Color temperature measurement	<ul style="list-style-type: none"> •Ambient light EV3 (20lx)~EV16.3 (200,000lx) •Flash light Range L: FNo.2.80 (20lx/s)~FNo.220 (1,300lx/s) Range H: FNo.160 (640lx/s)~FNo.909 (38,000lx/s)
	●Simple illuminance	<ul style="list-style-type: none"> •Ambient light 2.5lx~610,000lx 0.23FC~56,500FC
Ambient light repeat accuracy (20°C±5°C)	●Color temperature (Digital)	<ul style="list-style-type: none"> •LB index Within 2MK⁻¹ •CC index Within 0.8 displayed value •CC filter number Within 2 of displayed value
	●Color temperature (Film)	<ul style="list-style-type: none"> •LB index Within 2MK⁻¹ •CC filter number Within 2 of displayed value
	●Simplified illuminance	<ul style="list-style-type: none"> •lx/FC display Within +/-4% of displayed value
Display range	●Selected/preset color temperature	<ul style="list-style-type: none"> •Digital 100K step: 2,500K~10,000K 10MK⁻¹ step: 2,500K~10,000K Select type: 5,500K, 3,400K, 3,200K(3 types) 100K step: 2,500K~10,000K
	●Visual color temperature	<ul style="list-style-type: none"> •Digital 2,300K~20,000K (3 significant digits)
	●Photographic color temperature	<ul style="list-style-type: none"> •Film 2,300K~20,000K (3 significant digits)
	●LB index	<ul style="list-style-type: none"> •1MK⁻¹ step -500~+500MK⁻¹ •1daMK⁻¹ step Without decimal point: -50~+50daMK⁻¹ •0.1daMK⁻¹ step With decimal point: -50.0~+50.0daMK⁻¹
	●LB filter number	<ul style="list-style-type: none"> •Kodak Wratten/LEE 80A+80D~85B+81EF (40 types in all) •Fuji's LBA/LBB B20+B16~A20+A16 (57 types in all)
	●CC index	<ul style="list-style-type: none"> •80G~80M
	●CC filter number	<ul style="list-style-type: none"> •200G~200M

Specifications

	● Simplified illuminance display	• Ambient light	2.5~610,000lx (3 significant digits) 0.23~56,500FC (3 significant digits)
	● Shutter speed	• Flash light	1 second~1/500 second (in 1, 1/2, 1/3 step) plus: 1/75, 1/80, 1/90, 1/100, 1/200, 1/400 second
	● Preset display	• Digital • Film	None, PRESET1~PRESET19 None, PRESET1~PRESET19
	● Dot matrix display	• 1 character - 6×7 dots (5×7 valid dots), 10 characters	
	● Radio triggering channel display		
	※ C-500R only	• Main channel	ch1~ch32
		• Quad-triggering zone	A, B, C, D (ch17 to ch32 only)
Other functions	● Preset setting	• Preset 1~19 settings for each digital or film mode	
	● Jog wheel lock		
	● Custom settings	• 6 item settings possible	
	● Memory (Δ) function		
	● Out of measurement range or out of display range		
		• [L, Under] / [Q, Over] warning display	
	● Battery capacity indicator display		
		• With 3 level status icons	
	● Automatic power OFF function		
		• Time elapsed after last operation: about 20 min., about 10 min., about 5 min., none	
	● Automatic EL backlight on LCD screen		
		• Activates if illuminance is under EV6, 160lx or 15FC	
	● Tripod socket	• 1/4-inch, 20 threads	
Batteries used	● AA batteries	• 1.5Vx2 (Alkaline, manganese, lithium, NiCad, NiMH, nickel types)	
Operating temperature	● -10°C ~50°C		
Storage temperature	● -20°C ~60°C		
Dimensions	● Approx. 62 (width) ×159 (height) ×28 (depth) mm		
Weight	● C500: approx. 220g, C-500R: approx. 230g (with batteries)		
Included accessories	● Operating manual, Soft case, Strap, Sync terminal cap, Quick Guide, 2 AA dry cell alkaline batteries		

11-1. Glossary

Color Temperature	Color Temperature refers to the chromaticity of a heated object (commonly refer to as a black body) that will vary according to its temperature. The color temperature is measured in units of Kelvin (K) and refers to the temperature of a heated object at a given color or chromaticity. The higher the color temperature is, the bluer the light, and the larger the Kelvin value becomes. The lower the color temperature is, the redder the light, and the smaller the Kelvin value becomes. The color temperature of a heated object (black body radiator) is correlated to the color temperature of light and it is strictly defined as a correlated color temperature. Any reference to color temperature in this manual includes correlated color temperature.
Light	This refers to the electromagnetic wavelength ranging from 380nm to 780nm that can be detected by the human eye.
Black Body	Theoretically, this is an object that absorbs all wavelengths and when heated, emits light equivalent to the applied color temperature.
Black-body Radiation	This refers to the light emitted by a black body. The amount of energy released for each wavelength changes with the applied color temperature, resulting in visible color variations.
Correlated color temperature	3 sensors (R·G·B) matched to the spectral characteristics of the human eye (known as a color matching function) are used, and using the measurement values of the 3 sensors to calculate values known as chromaticity coordinates, the chromaticity diagram points are used to derive the correlated color temperature (K) and the deviation (Δuv). At this time, only the light source that is at the same point as a black-body that is considered to be a base color temperature is referred to as the "color temperature".
K	Expressed in absolute Kelvin temperature, with units of "K". 0 (zero) K is equivalent to -273.15 °C or -459.67°F.
Visual color temperature	Displayed by using 3 sensors (R·G·B) approximated to the spectral characteristics of the human eye (known as a color matching function) and calculating based on the ratio of the 3 sensors.
Photographic color temperature	Displayed by using 3 sensors (R·G·B) approximated to the spectral characteristic of films and calculating based on the ratio of the 3 sensors.
MK ⁻¹	Read as "per mega Kelvin", this unit is based on the International System of Units and equivalent to the traditional unit of MIRED (mrd). It expresses the inverse of color temperature. The inverse of color temperature is 1,000,000 divided by the color temperature. $\text{Inverse color temperature} = \frac{1,000,000}{\text{color temperature}}$ <p>The inverse color temperature decreases as the color temperature increases. Ex.) 10,000K = 100MK⁻¹, 3200K = 312.5MK⁻¹ If a 100K change is applied to both 10,000K and to 3200K, the human eye perceives the change applied to 3200K as larger. In other words, there is a difference in perception of the same change in color temperature depending on the color temperature's numerical value. When the inverse color temperature is used, the human eye perceives a given amount of change as the same for any color temperature.</p>
daMK ⁻¹	MK ⁻¹ divided by 10. Because the unit MK ⁻¹ is extremely small compared to the amount of change in color temperature the human eye can perceive, and because performing corrections is difficult, for practical purposes the unit daMK ⁻¹ (deca per mega Kelvin) is used. This unit is also used in conventional filters that change color temperature.
LB index	The difference of the reciprocal of the selected color temperature and the reciprocal of the measured color temperature. It is expressed in units of MK ⁻¹ (equivalent to MIRED) or daMK ⁻¹ .
LB filter	Stands for "Light Balancing Filter", and refers to a filter used for correcting color temperature in photography. A blue filter is used to raise the light source color temperature, while an amber filter is used to lower it. The filter number used in compensation can be expressed in daMK ⁻¹ , or deca Mired (1/10 of Mired), or the Kodak's Wratten or Lee's filter number. By using the custom settings in the C-500/C-500R, the display can be changed to show the type of the filter being used.
CC index	Number that expresses the amount of difference between the G component (green range) of the measured light source and the base black-body radiation of the color temperature. 1 CC index is equivalent to 2.5 CC filter number.
CC filter number	Stands for "Color Compensating Filter", and refers to a filter used for correcting color in photography. The 6 different types of this filter are yellow (Y), magenta (M), cyan (C), blue (B), green (G), and red (R), but the C-500/C-500R only uses the magenta (M) and green (G) types.

1 1-2. Exposure Corrections when using Filters

When using LB/CC filters based on the recommended compensation displayed in the meter, please note that the light entering the lens/camera will be less intense. If your camera doesn't have a Through the Lens (TTL) metering system, than use the chart below to determine the correct exposure compensation from the hand-held light meter's reading.

●LB Filters

Amber type				Blue type			
LB index (MK ⁻¹)	Manufacturer		Exposure Increase Increment (+EV)	LB index (MK ⁻¹)	Manufacturer		Exposure Increase Increment (+EV)
	Kodak/LEE Filter number	Fuji FilterNumber			Kodak/LEE Filter number	Fuji FilterNumber	
+9	81	-	1/3	-10	82	-	1/3
+10	-	LBA-1	0	-	-	LBB-1	0
+18	81A	-	1/3	-	-	-	-
+20	-	LBA-2	1/3	-20	-	LBB-2	1/3
+27	81B	-	1/3	-21	82A	-	1/3
+30	-	LBA-3	1/3	-30	-	LBB-3	1/2
+35	81C	-	1/3	-32	82B	-	2/3
+40	-	LBA-4	1/3	-40	-	LBB-4	2/3
+42	81D	-	2/3	-45	82C	-	2/3
+52	81EF	-	2/3	-56	80D	-	2/3
+80	-	LBA-8	2/3	-80	-	LBB-8	1
+81	85C	-	1/3	-81	80C	-	1
+112	85	-	2/3	-112	80B	-	12/3
+120	-	LBA-12	2/3	-120	-	LBB-12	12/3
+131	85B	-	2/3	-131	80A	-	2
+160	-	LBA-16	1	-160	-	LBB-16	2
+200	-	LBA-20	1	-200	-	LBB-20	21/3

●CC Filters

Magenta type			Green type		
Manufacturer		Exposure Increase Increment (+EV)	Manufacturer		Exposure Increase Increment (+EV)
Kodak/LEE Filter Number	Fuji Filter Number		Kodak/LEE Filter Number	Fuji Filter Number	
-	CC-1.25M	0	-	CC-1.25G	0
CC025M	CC-2.5M	0	CC025G	CC-2.5G	0
CC05M	-	1/3	CC05G	CC-5G	1/3
-	CC-5M	1/4			
-	CC-7.5M	1/3	-	CC-7.5G	1/3
CC10M	CC-10M	1/3	CC10G	-	1/3
			-	CC-10G	1/2
CC20M	-	1/3	CC20G	-	1/3
-	CC-20M	1/2	-	CC-20G	2/3
CC30M	CC-30M	2/3	CC30G	CC-30G	2/3
CC40M	CC-40M	2/3	CC40G	-	2/3
			-	CC-40G	1
CC50M	-	2/3	CC50G	-	1
-	CC-50M	1	-	CC-50G	11/3

12 Cautions when Using this Product

! Note

- Be sure not to drop the meter or subject it to sudden impact, as the meter will be damaged.
- Do not use the meter in a location where it may be subject to rain or splashes of water, as the meter will be damaged.
- Do not store the meter in areas of high temperature or high humidity, as the meter will be damaged.
- Be careful of condensation caused by sudden changes in temperature. It will cause damage or malfunction of the meter.
- If the temperature goes below -10°C , the response of the liquid crystal display will slow down greatly and the display will become difficult to read. Between $0\sim 10^{\circ}\text{C}$, the liquid crystal display response will slow down somewhat but the meter will not be harmed. Also, if the temperature exceeds 50°C , the liquid crystal display will darken and become difficult to read, but when it returns to room temperature it will return to its normal condition.
- If the meter is left in direct sunlight or near a heater, the unit's temperature will rise and may result in damage. Please be careful when using the meter in these types of locations.
- Do not operate with battery door open.
- Do not operate the device in the presence of flammable gasses or fumes.

Maintenance Notes

- Because it may affect the precision of the measurements, be careful not to let the Flat diffuser (Lumidisc) of the light receptor become dusty, dirty, or scratched.
- If the meter becomes dirty, wipe it with a dry, soft cloth. Never use organic solvents such as thinner or benzene.
- Refer servicing only to qualified and authorized personnel in case of product's malfunction.

FCC & IC compliance information:

Warning

- Changes or modifications to this unit not expressly approved by the party responsible for compliance could void the user's authority to operate the equipment.

Note

- This equipment has been tested and found to comply with the limits for a Class B digital device, pursuant To Part 15 of the FCC Rules. These limits are designed to provide reasonable protection against harmful interference in a residential installation. This equipment generates, uses, and can radiate radio frequency energy and, if not installed and used in accordance with the instruction, may cause harmful interference to radio communication.

However, there is no guarantee that interference will not occur in a particular installation. If this equipment does cause harmful interference to radio or television reception, which can be determine by turning the equipment off and on, the user is encouraged to try to correct the interference by one or more of the following measures:

- * Reorient or relocate the receiving antenna.
- * Increase the separation between the equipment and receiver.
- * Consult the dealer or an experienced radio/TV technician for help.

This device complies with Part 15 of the FCC rules and also with RSS-210 of Industry Canada. Operation is subject to the following two condition: (1) This device may not cause harmful interference, and (2) this device must accept any interference received, including interference that may cause undesired operation.

FCC ID Number: PFK-500-01

IC ID Number: 3916A-500001

Memo

SEKONIC CORPORATION

7-24-14, Oizumi-Gakuen-cho, Nerima-ku, Tokyo
178-8686 JAPAN
TEL +81-3-3978-2366 FAX +81-3-3922-2144
<http://www.sekonic.co.jp>