

# FLASHPOINT



FPLFSMZLXPF

**ZOOM LI-ON X PRO R2 TTL  
SPEEDLIGHT FOR FUJIFILM**

ROUND HEAD ZOOM WITH R2 TRANSCEIVER

## Important Safety Instructions



This product is a professional photographic equipment, to be operated by professional personnel only.

The following basic safety precautions must be followed when using this product: All transport protective materials and packaging on the product must be removed before use.

1. Carefully read and fully understand the instruction manual before use and strictly follow the safety instructions. Failure to do so may result in death, serious injury, damage to the product, or other property damage.
2. This product is a professional lighting fixture, children are prohibited from using it. Children must be closely supervised by adults when approaching the fixture, to prevent collisions with the fixture or unauthorized use that could cause personal injury.
3. This is not an ordinary lighting fixture and must not be used for general illumination. Anyone with a history of eye damage or sensitivity should avoid using this fixture or looking directly at it.
4. Extreme caution must be exercised when using it, do not touch high-temperature parts such as flash tubes to avoid burns.
5. Do not point the flash directly at the eyes (especially baby's eyes) under any circumstances, as this could impair vision in a short time. Turn off immediately if discomfort occurs, stop using, and seek medical attention promptly.
6. Do not use damaged equipment or accessories. Allow professional repair technicians to inspect and confirm normal operation before continuing use after repairs.
7. Stop using immediately if the product shell is cracked due to falling, squeezing, or strong impact, to avoid touching the internal electronic components and getting an electric shock.
8. This device is not waterproof. Keep it dry and avoid immersing it in water or other liquids. It should be installed in a ventilated and dry location and avoid using in rainy, humid, dusty, or overheated environments. Do not place items above the device or allow liquids to flow into it to prevent danger.
9. Do not disassemble without authorization. If the product malfunctions, it must be inspected and repaired by our company or authorized repair personnel.
10. Before storing the device, ensure it has completely cooled down.
11. Do not place the device near alcohol, gasoline, or other flammable volatile solvents or gases such as methane and ethane.
12. Do not use or store this device in potentially explosive environments.
13. Maintain at least 1 meter distance between the lamp head and the user, other people, and heat-sensitive or flammable items during and after use.

14. Do not use accessories not been approved by our company, as this may cause fire, electric shock or personal injury.
15. Clean gently with a dry cloth. Do not use a wet cloth as it may damage the device.
16. This instruction manual is based on rigorous testing. Changes in design and specifications are subject to change without notice. Check official website for latest instruction manual and product updates.
17. This product is powered by lithium batteries, who have limited lifespans and will gradually lose their charging capacities, which is irreversible. As the battery ages, the product's battery life will decrease. The lifespan of lithium battery is estimated to be 2 to 3 years. Please regularly check the battery, and if the charging time significantly increases or the battery life significantly decreases, consider replacing the battery.
18. This product is equipped with lithium batteries. The following are the storage recommendations: Charge the battery to about 50% before storage. Charge it to about 50% at least every six months. Removable batteries should be stored separately. The storage temperature should be between 0°C and 40°C.
19. Precautions for using lithium batteries:
  - Do not disassemble, crush, or puncture the battery.
  - This battery is not waterproof, keep it dry and avoid immersing it in water or fog.
  - Avoid short-circuiting the battery contacts.
  - Do not expose the battery to or put it into fire.
  - Do not expose the battery to temperatures above 60°C.
  - Keep out of reach of children.
  - Protect the battery from excessive shock or vibration.
  - Do not use a damaged battery.
  - If the battery leaks, avoid contact with the leaking fluid.
  - If the battery fluid comes into contact with your eyes, immediately rinse with water for at least 15 minutes. Lift your eyelids until there are no signs of fluid and seek medical attention promptly.
20. Confirm and comply with all relevant local laws and regulations when handling any batteries.
21. The warranty period for this device as a whole is one year. Consumables (such as batteries), adapters, power cords, and other accessories are not covered by the warranty.
22. Unauthorized repairs will void the warranty and will incur charges.
23. Please check the status and power of the lithium battery upon receipt. If there are any quality issues, please contact Flashpoint or our authorized dealer within the warranty period.
24. Failures from improper operation is not covered under warranty.

# Content

|    |   |
|----|---|
| 4  | Foreword  |
| 4  | Main Features   |
| 5  | Name of Parts   |
| 5  | Body  |
| 6  | Control Panel   |
| 6  | Detachable Sub Flash SU-1   |
| 7  | LCD Panel   |
| 9  | What's Inside   |
| 9  | Separately Sold Accessories   |
| 10 | Battery   |
| 10 | Battery Level Indication  |
| 10 | Power Management  |
| 11 | Modeling Lamp   |
| 11 | Mounting/Detaching the Camera Flash   |
| 12 | Installing/Detaching SU-1   |
| 12 | Using SU-1  |
| 13 | Flash Mode - TTL: Auto Flash  |
| 13 |  FEC (Flash Exposure Compensation) |
| 14 |  High-Speed Sync                   |
| 14 |  Second-Curtain Sync               |
| 15 | Flash Mode - M: Manual Flash  |
| 16 | Flash Mode - Multi: Stroboscopic Flash  |
| 19 | Wireless Flash Shooting: 2.4G Wireless Transmission   |
| 22 | Wireless Settings   |
| 22 | Setting the Transmitter Unit Flash Mode   |
| 23 | Wireless Channel Settings   |
| 23 | ID Settings   |
| 24 | Scan the Spare Channel  |
| 24 | TTL: Fully Automatic Wireless Flash Shooting  |
| 27 | M: Wireless Flash Shooting with Manual Flash  |
| 28 | Multi: Wireless Flash Shooting with Manual Flash  |
| 29 | TTL/M Mode Switch Function  |
| 29 | Screen Lock   |
| 29 | Mode Lock   |
| 29 | The Reason & Solution of Not Triggering in Flaspont 2.4G Wireless   |
| 30 | Other Applications  |
| 30 | Sync Triggering   |
| 30 | Auto Focus Assist Beam  |
| 30 | Bounce Flash  |
| 31 | ZOOM: Setting the Flash Coverage  |
| 31 | Low Battery Warning   |
| 32 | C.Fn: Setting Custom Functions  |
| 33 | Protection Function   |
| 34 | Technical Data  |
| 35 | Troubleshooting   |
| 36 | Firmware Upgrade  |
| 36 | Compatible Camera Models  |
| 37 | Maintenance   |
| 38 | FCC Warning   |
| 39 | Warranty and Customer Service   |

# Foreword

Thank You for Choosing **FLASHPOINT!**

This **Zoom Li-on X Pro F** camera flash applies to FUJIFILM cameras and is compatible with TTL auto flash. With this TTL compatible flash, you will get a simpler and better shooting experience, easily achieve a correct flash exposure even in complex light-changing environments.

## Main Features

- With round lens to achieve soft, even and more creative light effects.
- 2W LED modeling lamp with brightness adjustment from 1 to 10.
- 76Ws flash power output at 1/1 step in M mode, 81 steps adjustable from 1/1 to 1/256.
- 7.2V/2980mAh lithium battery provides 1.3s recycle time at 1/1 step.
- Fully support FUJIFILM TTL camera flash. Workable as transmitter or receiver unit in a wireless flash group.
- Use dot-matrix LCD panel to achieve clear and convenient operations.
- With built-in 2.4GHz wireless system to support remote transmitting and receiving.
- Can be collocated with power pack BP-960 to achieve quicker recycle time.
- Support use with detachable sub flash SU-1 for better filling light.
- Provide multiple functions, include manual flash, multi flash, HSS, Second-Curtain Sync, FEC, etc.
- Stable consistency in brightness and color temperature with good even lighting.
- Support firmware upgrade to better compatible with Canon cameras.

**Note:** Power pack BP-960 is sold separately.

# Name of Parts

## Body

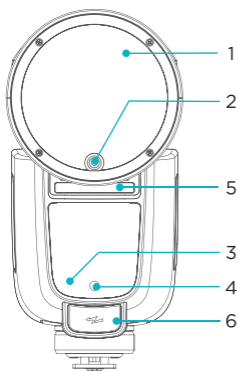

1. Flash Head
2. LED Modeling Lamp
3. Optical Sensor
4. Focus Assist Beam
5. External Flash Interface
6. External Power Pack Port
7. Bounce Angle Scale
8. Hot Shoe
9. LCD Panel
10. Hot Shoe Fixing Buckle
11. Lithium Battery
12. Hot Shoe Lock Ring
13. USB-C Charging Port
14. Charging Indicator

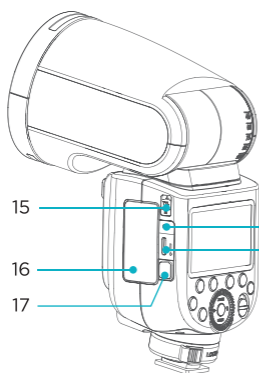
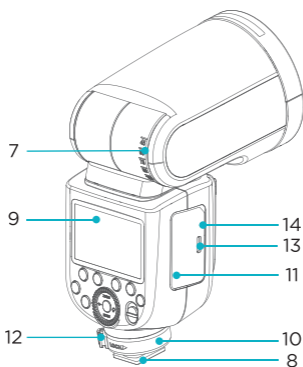

15. TTL/M Mode Toggle Switch
16. Battery Compartment
17. Battery Remove Button
18. Sync Cord Jack
19. USB-C Upgrading Port

## Control Panel

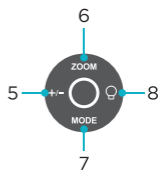
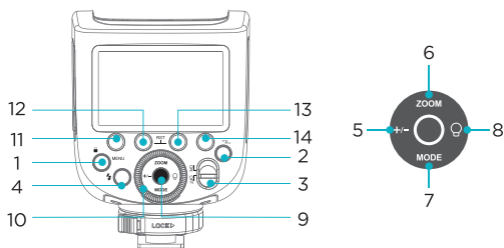

1. **MENU / < LOCK >** Button
2. **< WIRELESS >** Wireless Button
3. ON / OFF Power Switch
4. Test Button / Recycle Indicator
5. **< +/- >** FEC / Flash Output Setting Button
6. **< ZOOM >** Zoom Button
7. **< MODE >** Mode Button
8. LED Modeling Lamp Button
9. Set Button
10. Select Dial
11. Function Button 1
12. Function Button 2
13. Function Button 3
14. Function Button 4

## Detachable Sub Flash SU-1

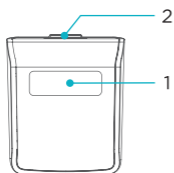

1. Flash Tube
2. Detaching Pusher

## LCD Panel

### TTL Auto Flash

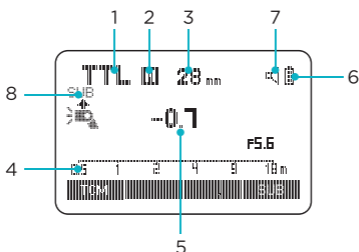

1. **TTL**: TTL Auto Flash
2. **A**: Auto Zoom     **M**: Manual Zoom
3. Zoom Display (Auto/28-105mm) or (Auto/18-69mm)
4. Effective Flash Range/Shooting Distance (m/ft)
5. Flash Exposure Compensation Amount
6. Battery Level Indication
7. Beeper
8. Sub Flash SU-1 ON

### Manual Flash



1. **M**: Manual Flash
2. Manual Flash Output
3. S1/S2 Optical Control
4. Sub Flash SU-1 ON
5. **HS**: High-Speed Sync

- The display will only show the settings currently applied.
- The functions displayed above function buttons 1 to 4, such as **< SYNC and M / A / B / C >**, change according to settings's status.
- When a button or dial is operated, the LCD panel will be illuminated.
- The **< SUB >** icon will display on the panel only after the sub flash is inserted into the flash.



## Multi Flash

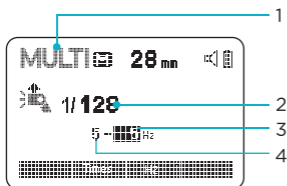

1. **MULTI**: Stroboscopic Flash
2. Multi Flash Output
3. Flash Frequency
4. Number of Flashes

## Radio Transmission Shooting:

### Transmitter Unit (2.4G Wireless Transmitting)

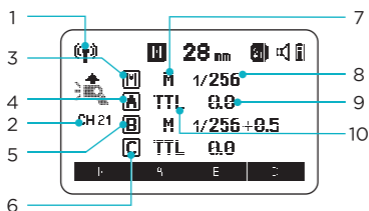

1. Radio Transmission Shooting
2. Transmitter Channel
3. **Group M**: Transmitter Unit Group M
4. **Group A**: Receiver Unit Group A
5. **Group B**: Receiver Unit Group B
6. **Group C**: Receiver Unit Group C
7. **M**: Manual Flash
8. Flash Output
9. Flash Exposure Compensation Amount
10. **TTL**: TTL Auto Flash

### Receiver Unit (2.4G Wireless Receiving)

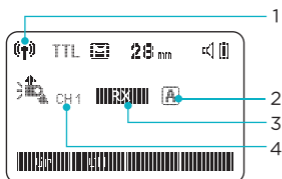

1. Radio Transmission Shooting
2. Receiver Unit Group
3. Receiver Unit (2.4G Wireless Receiving)
4. 2.4G Wireless Receiving Channel

## What's Inside



Flash Body



Storage Bag



Charger



Mini Stand



USB-C Charging Cable



Lithium Battery



Detachable Sub Flash SU-1



Instruction Manual

## Separately Sold Accessories

The product can be used in combination with the following accessories sold separately, so as to achieve the best photography effects:

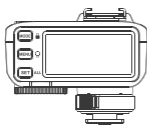

TTL Wireless Flash Trigger R2 Mark II F

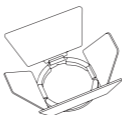

Accessory Kit for Round Flash Head AK-R1



TTL Wireless Flash Trigger R2 XPro II F

## Battery

**Detaching battery:**

**Installing battery:**

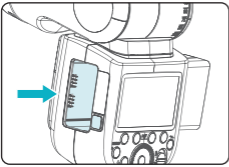

Press and hold the battery remove button, then push the battery out of the battery compartment.

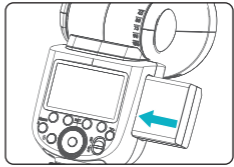

Insert the battery into the battery compartment in the direction as referred below until it's firmly locked.

## Battery Level Indication

Make sure the battery pack is securely loaded in the flash. Check the battery level indication on the LCD panel to see the remaining battery level.

| Battery Level Indication | Meaning  |
|--------------------------|--|
| 3 grids                  | Full   |
| 2 grids                  | Middle   |
| 1 grid                   | Low  |
| Blank grid               | Lower battery, please recharge it.   |
| Blinking                 | The battery level is going to be used out, and the flash is not functional in this status.<br><b>Note:</b> Please recharge the battery as soon as possible (within 10 days). Then, the battery can be used or be placed for long period. |

## Power Management

Use ON/OFF power switch to power the flash unit on or off. Turn off if it will not be used for an extended period of time.

Setting as a transmitter unit, the flash will turn the power off automatically after a certain period (approx. 90 seconds) of idle use. Press the camera shutter halfway or press any flash button will wake up the flash unit. Setting as a receiver flash, it will enter sleep mode after 60 minutes (or 30 minutes) of idle use. Pressing any flash button will wake it up.

- Setting the C.Fn-STBY function to OFF is recommended when the flash is used off camera.
- Auto power off timer function of a receiver unit is set to 60 minutes by default. Another option "**30 minutes**" is available in C.Fn-RX.
- The LCD panel will lighten on when operating the buttons or select dial.

## Modeling Lamp

Press the modeling lamp button to set the modeling lamp, press the set button to turn on or off the modeling lamp. When turning the modeling lamp on, turn the select dial to adjust its brightness in 10 levels (01-10).

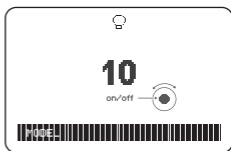

## Mounting/Detaching the Camera Flash

### Mounting the camera flash:

Press the hot shoe fixing buckle and rotate it to the left, insert the camera flash into the camera's hot shoe.

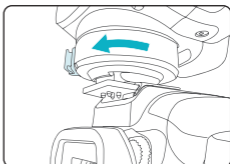

Then rotate it to the right until it locks up.

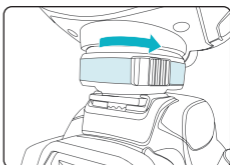

### Detaching the camera flash:

Press and rotate the hot shoe fixing buckle to the left until it is loosened, then take off the camera flash.

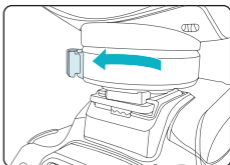

## Installing/Detaching SU-1

### Installing:

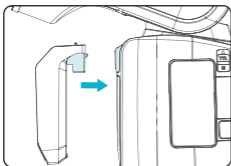

Align the detachable sub flash SU-1 with the external flash interface of Zoom Li-on X Pro F and insert it parallelly, then press it down, a "click" sound means it's properly installed.

### Detaching:

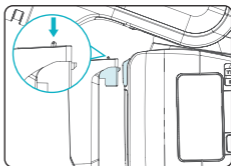

Push the detaching pusher on SU-1 and pull it up at the same time to detach it.

## Using SU-1

With detachable sub flash SU-1 attached to the external flash interface of Zoom Li-on X Pro F, better filling light effects can be achieved in M (manual) flash / TTL auto flash mode, this is helpful for portrait shooting.

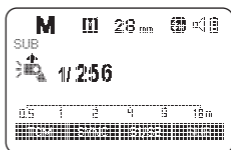

## Instructions for Using:

Mount SU-1 directly to the external flash interface of Zoom Li-on X Pro F, press the MODEL button to set the flash to M (manual) flash/TTL auto flash mode, then press function button 4 < SUB > to enter sub flash settings interface, and press function button 3 < ON / OFF > to turn on/off.



When the sub flash is turned on, turn the select dial can adjust flash output of the sub flash from 1/128 to 1/1 in 22 flash steps, with +1/3 increment each step.

- SU-1 is not useable in wireless transmission shooting.
- SU-1 is not useable in high-speed sync.
- The flash head need to be uplifted in order to use SU-1 properly.

## Flash Mode - TTL: Auto Flash

In TTL mode, the camera's metering system detects the flash reflected from the subject and automatically adjusts the flash output so that the subject and background are evenly exposed. In this mode, multiple functions are available: FEC, HSS, second curtain sync, etc.

Press **< MODE >** mode button to enter TTL mode, the LCD panel will display **< TTL >**.

- Press the camera shutter halfway to focus. The aperture value and effective flash range will be displayed in the LCD panel.
- When the shutter is fully pressed, the flash will fire a pre-flash that the camera will use to calculate exposure and flash output the instant before the photo is taken.

### **FEC (Flash Exposure Compensation)**

With FEC function, this flash can adjust from -3 to +3 with 1/3 increment each step. It is useful in situations where minor adjustment of the TTL system is needed based on the environment.

#### Setting FEC Amount

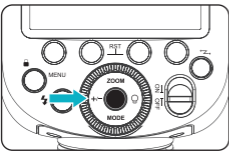

- 1** Press the **< +/- >** button, FEC amount will be highlighted on the LCD panel.

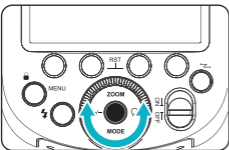
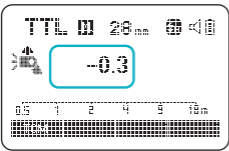

- 2** Turn the select dial to set the FEC amount.

**"0.3"** means 1/3 step

**"0.7"** means 2/3 step.

To cancel the FEC, set the amount to **"0"**.

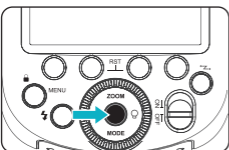

- 3** Press set button again to confirm the setting.

## High-Speed Sync

High speed sync (FP flash) enables the flash to synchronize with all camera shutter speeds. This is convenient when you want to use aperture priority for fill-flash portraits.

Setting the flash to high-speed sync mode when it is on the camera:

Use the **< Flash Setting >** Flash Light Function Setting on the camera's shooting menu to adjust settings the flash. More details please refer to camera's instruction menu.

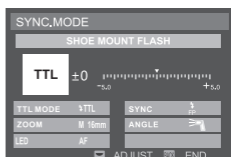

Flash Light Function Setting Interface of R2-T2

- When choosing FP on the **"SYNC"** setting, it means the high-speed sync function is turned on.
- With high-speed sync, the faster the shutter speed, the shorter the effective flash range.
- Multi flash mode cannot be set in high-speed sync mode.
- Over-temperature protection may be activated after 60 consecutive high-speed sync flashes.

## Second-Curtain Sync

With a slow shutter speed and second-curtain sync, you can create a light train following the subject. The flash fires right before the shutter closes.

Setting second-curtain sync:

Use the **< Flash Setting >** Flash Light Function Setting on the Use the camera's shooting menu to adjust settings of the flash. More details please refer to camera's instruction menu.

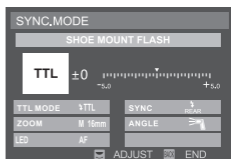

Flash Light Function Setting Interface of R2-T2

- When choosing REAR on the **"SYNC"** setting, it means the second-curtain sync function is turned on.

## Flash Mode - M: Manual Flash

The flash output is adjustable from 1/1 full power to 1/256 power with 1/10 increment each step. To obtain a correct flash exposure, use a hand-held flash meter to determine the required flash output.

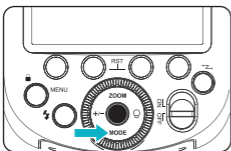

**1** Press **< MODE >** mode button so that **< M >** is displayed on the LCD panel.

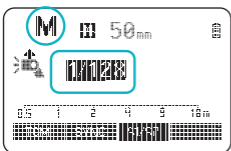

**2** Press the **< +/- >** button to select flash output amount, then turn the select dial to adjust it. Press the set button again to confirm the setting.

### S1 Optic Control Unit Setting

In M manual flash mode, press **< S1/S2 >** button so that this flash can function as an optic S1 secondary flash with optic sensor. With this function, the flash will fire synchronously when the main flash fires, the same effect as that by the use of wireless triggers. This helps create multiple lighting effects.

### S2 Optic Control Unit Setting

In M manual flash mode, press **< S1/S2 >** button so that this flash can also function as an optic S2 secondary flash with optic sensor. This is useful when cameras have pre-flash function. With this function, the flash will ignore a single **"pre-flash"** from the main flash and will only fire in response to the second, actual flash from the main flash.

- S1 and S2 optic control triggering is only available in M manual flash mode.
- Press function 3 button **< S1/S2 >** to switch between S1/S2 optic control or turn off this function.



# Flash Mode - Multi: Stroboscopic Flash

With slow shutter speed in multi flash mode, a rapid series of flashes is fired. It can be used to capture multiple images of a moving subject in a single photograph.

You can set the flash frequency (number of flashes per sec. expressed as Hz), the number of flashes, and the flash output.

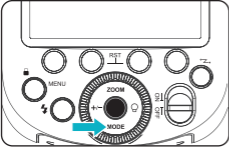

- 1 Press **< MODE >** mode button so that **< Multi >** is displayed on the LCD panel.

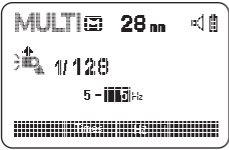

- 2 Press the function button 2 **< Times >** to select the number of flashes. Turn the select dial to set the number, then press it to confirm the settings. Press the function button 3 **< Hz >** to select the flash frequency. Turn the select dial to set the frequency, then press it to confirm the settings.

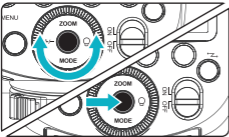

- 3 Press **< +/- >** button to select flash output amount. Turn the select dial to set the amount, then press it to confirm the settings.  
Flash output range: 1/256-1/4.

## Calculating the Shutter Speed

During multi flash, the shutter remains open until the firing stops. Use the formula below to calculate the shutter speed and set it with the camera.

### Number of Flashes / Flash Frequency = Shutter Speed

For example, if the number of flashes is 10 and the flash frequency is 5Hz, the shutter speed should be at least 2 seconds.

 To avoid overheating and deteriorating the flash head, do not use multi flash more than 10 times in succession. After 10 times, allow the camera flash to rest for at least 15 minutes. If you try to use the multi flash more than 10 times in succession, the firing might stop automatically to protect the flash head. If this happens, allow at least 15 minutes' rest for the camera flash.

-  Multi flash is most effective with a highly reflective subject against a dark background.
- Using a tripod and TTL flash trigger R2 XPro II is recommended.
- A flash output of 1/1 and 1/2 cannot be set for multi flash.
- Multi flash can also be used with **"BULB"** mode.
- Multi flash mode cannot be set in high-speed sync mode.
- If the number of flashes is displayed as **"--"**, the firing will continue until the shutter closes or the battery is exhausted. The number of flashes will be limited as shown by the following table.

## Maximum Time of Consecutive Flashes:

| Flash Output \ Hz | 1  | 2  | 3  | 4  | 5  |
|-------------------|----|----|----|----|----|
| 1/4               | 8  | 6  | 4  | 3  | 3  |
| 1/8               | 14 | 14 | 12 | 10 | 8  |
| 1/16              | 30 | 30 | 30 | 20 | 20 |
| 1/32              | 60 | 60 | 60 | 50 | 50 |
| 1/64              | 90 | 90 | 90 | 80 | 80 |
| 1/128             | 90 | 90 | 90 | 90 | 90 |
| 1/256             | 90 | 90 | 90 | 90 | 90 |

| Flash Output \ Hz | 6-7 | 8-9 | 10 | 20-50 | 60-100 |
|-------------------|-----|-----|----|-------|--------|
| 1/4               | 2   | 2   | 2  | 2     | 2      |
| 1/8               | 6   | 5   | 4  | 4     | 4      |
| 1/16              | 20  | 10  | 8  | 8     | 8      |
| 1/32              | 40  | 30  | 20 | 16    | 12     |
| 1/64              | 70  | 60  | 50 | 30    | 20     |
| 1/128             | 90  | 80  | 70 | 40    | 40     |
| 1/256             | 90  | 80  | 70 | 40    | 40     |

## Wireless Flash Shooting: 2.4G Wireless Transmission

- This section explains wireless transmitting/receiving flash shooting.
- The Zoom Li-on X Pro F attached to the camera is referred as the transmitter unit, while a Zoom Li-on X Pro F that is wirelessly controlled is referred as the receiver unit.
- You can also wirelessly control the Zoom Li-on X Pro F set as the receiver unit with the TTL flash trigger R2 XPro II (sold separately). For details on setting the flash trigger functions, see the its instruction manual.
- Using a flash with a radio transmission wireless shooting function make it easy to shoot with advanced wireless multiple flash shooting, in the same way as TTL auto flash shooting.
- As long as the channel, group, ID, and other relevant wireless settings of the transmitter and receiver units are set to the same, the settings on the Zoom Li-on X Pro F (transmitter unit) will be automatically applied to the wirelessly controlled Zoom Li-on X Pro F (receiver unit). Therefore, there is no need to operate the receiver unit during shooting.

## Positioning and Operation Range (Example of wireless flash shooting)

- Autoflash Shooting with One Receiver Unit

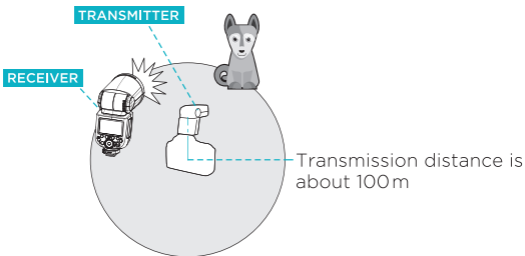

- Before shooting, perform a test flash and test shooting.
- The transmission distance might be shorter depending on the conditions such as positioning of receiver units, the surrounding environment and whether conditions.

## Auto Flash Shooting with Multiple Receiver Groups

You can divide the receiver units into two or three groups and perform TTL auto flash while changing the flash ratio (flash output ratio). In addition, you can set and shoot with a different flash mode for each firing group, for up to 4 groups.

- Auto Flash Shooting with Two Receiver Groups

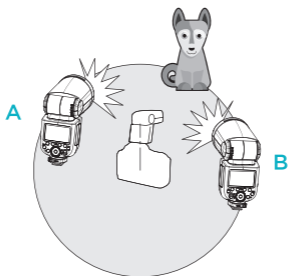

- Auto Flash Shooting with Three Receiver Groups

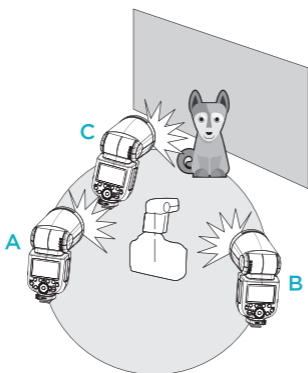

## Wireless Settings

You can switch between normal flash and wireless flash. For normal flash shooting, be sure to set the wireless setting to "OFF", and the <Ⓜ> won't be displayed on the LCD panel.

### Setting the Flash as A Transmitter Unit

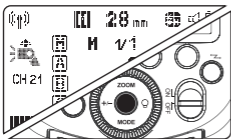

Press <Z> button so that <Ⓜ> is displayed on the LCD panel, but the <RX> won't be displayed.

### Setting the Flash as A Receiver Unit

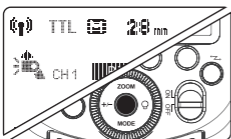

Press <Z> button so that <Ⓜ> and <RX> are displayed on the LCD panel.

## Setting the Transmitter Unit Flash Mode

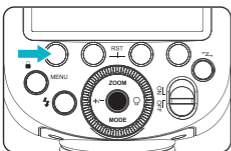

**1** Press the <Z> wireless button to make <Ⓜ> is displayed on the panel while <RX> is not displayed. Press the function button 1 <M> to select --/TTL/M. Choose one of them as the flash mode of the transmitter unit.

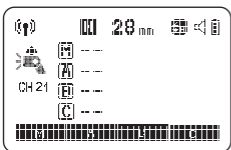

**2** Press <MODE> button to switch to Multi mode.

## Wireless Channel Settings

If there are other wireless flash systems nearby, you can change the wireless channels to prevent signal interference. The wireless channels of the transmitter unit and the receiver unit(s) must be set to the same.

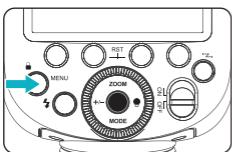

- 1 Press **< MENU >** menu button to enter menu setting. Turn the select dial to **< CH >**, then press the set button to choose CH.

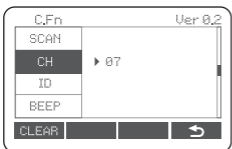

- 2 Turn the select dial to adjust wireless channel from 01 to 32. Press the set button to confirm.

## ID Settings

Change the wireless channels and wireless ID to avoid interference for it can only be triggered after the wireless channels and IDs of the transmitter unit and the receiver unit are set to the same. Press the menu button to enter C.Fn ID, press the set button to choose OFF to turn off the wireless ID, or choose any figure from 01 to 99.

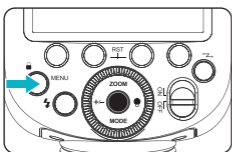

- 1 Press **< MENU >** menu button to enter menu setting. Turn the select dial to **< ID >**, then press the set button to choose ID.

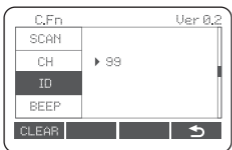

- 2 Turn the select dial to adjust wireless ID from 01 to 99 or OFF. Press the set button to confirm.



## Scan the Spare Channel

You can scan the spare channel to avoid the interference of using the same channel by others.

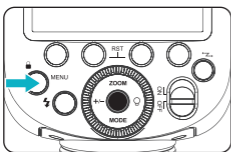

- 1 Press **< MENU >** menu button to enter menu setting. Turn the select dial to **< SCAN >**, then press the set button to choose **SCAN**.

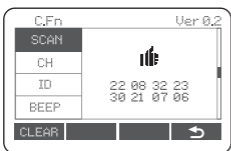

- 2 Turn the select dial to choose **START**, then press the set button to scan. And the 8 spare channels will be displayed for your choice.

## TTL:

### Fully Automatic Wireless Flash Shooting

- Using Automatic Wireless Flash with a Single Receiver Unit

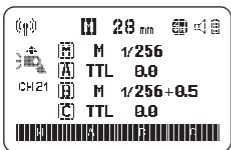

- 1 **Transmitter Unit Setting**  
Press the wireless button and the **< (P) >** icon is displayed on the LCD panel, then the Zoom Li-on X Pro F attached to the camera is set as the transmitter unit.

Set the R2 Mark II F mounted on the camera as a transmitter unit, then M/A/B/C group can be set as TTL mode separately.

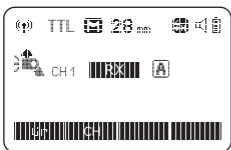

- 2 **Receiver Unit Setting**  
Press the wireless button and the **< RX >** is displayed on the LCD panel, then the Zoom Li-on X Pro F wirelessly controlled is set as the receiver unit A/B/C/D/E.

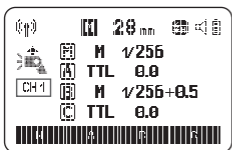

### 3 Check the Communication Channel

Set the wireless channels of transmitter unit and receiver unit to the same. For example, if the transmitter unit channel is set to 01, then the receiver unit channel needs to be 01 as well.



### 4 Position the Camera and Flashes

The transmission distance of the transmitter unit and receiver unit is about 100m.

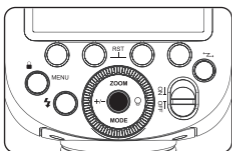
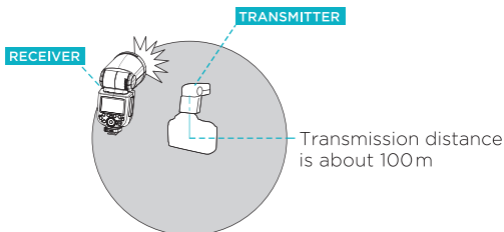

### 5 Check Whether the Flash is Ready

Check whether the transmitter unit's flash ready indicator is lightened. When the receiver unit's flash is ready, the AF-assist beam lighting area will blink at 1 second intervals.

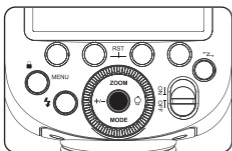

### 6 Check the Flash Operation

Press the transmitter unit's test button . Then, the receiver unit will fire. If not, adjust the distance from the transmitter unit.

## • Using Automatic Wireless Flash with Multiple Receiver Units

When stronger flash output or more convenient lighting operation is needed, increase the number of receiver units and set it as a single receiver unit. To add receiver units, use the same steps as setting **"using automatic wireless flash with a single receiver unit"**.

Any flash group can be set (A/B/C/D/E).

When the number of receiver units is increased

or the transmitter unit flash firing is ON, automatic control is implemented to make all groups of flashes fire the same flash output and ensure the total flash output is up to standard exposure.

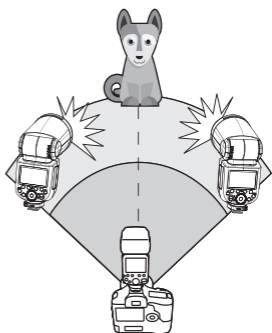

- If the receiver unit's auto power off function is on, press the transmitter unit's test button to power it on. Please note that test firing is unavailable during the camera's regular metering time.
- By pressing the menu button to enter C.Fn setting, the effective time of receiver unit's auto power off is changeable between 60min or 30min (RX STBY).

## • Using Fully Automatic Wireless Flash

The FEC and other settings that set on the transmitter unit will also be appeared on the receiver unit automatically. The receiver unit does not need any operation. Use the following settings to make wireless flash shooting according to the same methods with normal flash shooting.

• Flash Exposure Compensation

## • About Transmitter Unit

Use two or more transmitter units. By preparing several cameras that with transmitter units attached, cameras can be changed in shooting while keeping the same lighting source (receiver unit).

# M: Wireless Flash Shooting with Manual Flash

Using wireless (multiple flash) shooting with manual flash, you can shoot with a different flash output setting for each receiver unit (flash group) while setting all parameters on the transmitter unit.

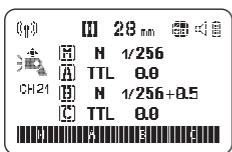

## 1 Set the Transmitter Unit's Flash Group to < M >

Press the wireless button and the < [signal icon] > icon is displayed on the LCD panel, then the Zoom Li-on X Pro F attached to the camera is set as the transmitter unit. Press the corresponding function button 1/2/3/4 < M / A / B / C > to make < M > is displayed in all the flash groups on the LCD panel.

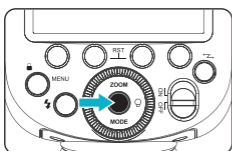

## 2 Set the Flash Output of Each Flash Group

Press function button < M / A / B / C > to choose a group. Turn the select dial to set the flash output of the group, then press the set button to confirm.

## 3 Set the Wireless Channels of Transmitter Unit and Receiver Unit to the Same

For example, if the transmitter unit channel is set to 01, then the receiver unit channel needs to be 01 as well.

## 4 Take Picture

Each receiver unit fires at the set flash ratio.

# Multi: Wireless Flash Shooting with Manual Flash

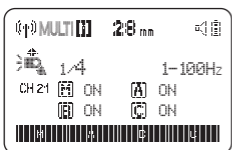

- 1** Set the Transmitter Unit to Wireless Multi Flash  
Press **< MODE >** mode button so that **< Multi >** is displayed on the LCD display, then press the wireless button so that **< Multi >** and **< (P) >** are displayed on the LCD display at the same time.

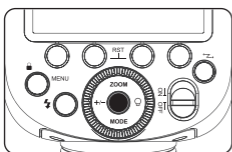

- 2** Set the Flash Output, Number of Flashes and Flash Frequency of the Wireless Multi Flash  
Press **< +/- >** button to select flash output of multi flash. Turn the select dial to set the flash output amount, then press the set button to confirm the settings and exit. Press the set button to select number of flashes of flash frequency. Turn the select dial to set the number of flashes of flash frequency, then press the set button to confirm the settings and exit.

- 3** Turn On/Off the Wireless Multi Flash of Receiver Unit Group  
The wireless multi flash of receiver unit **A / B / C** can be turned on or off directly on the transmitter unit.
- 4** Set the Receiver Unit  
Press the wireless button to make the **< Multi >** and **< RX >** are displayed on the LCD panel of the receiver unit.
- 5** Set the Wireless Channels of Transmitter Unit and Receiver Unit to the Same  
For example, if the transmitter unit channel is set to 01, then the receiver unit channel needs to be 01 as well.

 • The parameters of receiver unit can be directly set on the transmitter unit on the condition that channels and IDs of them are set to the same.

## TTL/M Mode Switch Function

1. Toggle the TTL/M mode toggle switch in non-wireless mode can switch flash mode.
2. TCM switch function is workable by default when switched to M manual mode from TTL mode.

### Screen Lock

Press and hold the **< Ⓛ >** button for 2s can lock or unlock the screen, **"LOCKED"** is displayed on the LCD panel when the screen is locked.



### Mode Lock

Press and hold the **< MODE >** button to make the **< Ⓛ >** is displayed on the panel, the current flash mode (TTL / M / RPT flash mode) is locked, press and hold again to unlock, then the flash mode can be switched by pressing the **< MODE >** button.

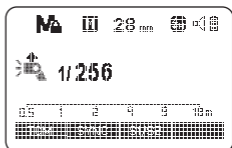

## The Reason & Solution of Not Triggering in Flashpoint 2.4G Wireless

1. Disturbed by the 2.4G signal in outer environment (e.g. wireless base station, 2.4G wifi router, Bluetooth, etc.)
  - To adjust the channel CH setting on the flash trigger (add 10+ channels) and use the channel which is not disturbed. Or turn off the other 2.4G equipment in working.
2. Please make sure that whether the flash has finished its recycle or caught up with the continuous shooting speed or not (the flash ready indicator is lightened) and the flash is not under the state of over-heat protection or other abnormal situations.
  - Please downgrade the flash power output. If the flash is in TTL mode, please try to change it to M mode (a pre-flash is needed in TTL mode).
3. Whether the distance between the flash trigger and the flash is too close or not (<0.5m).
  - Please turn on the **"close distance wireless mode"**:
    - R2 Series:** Press and hold the triggering button then turn on the device until the indicator blinks twice.
    - R2 Pro and R2 mark II Series:** Set the C.Fn-DIST to 0-30m.
    - R2 nano F:** Set the trigger distance to 0-30m.
4. Whether the flash trigger and the receiver end equipment are in the low battery states or not.
  - Please replace the battery.

## Other Applications

### Sync Triggering

The sync cord jack is a  $\Phi 2.5\text{mm}$  plug. Insert a trigger plug here and the flash will be fired synchronously with the camera shutter.

### Auto Focus Assist Beam

In poorly-lit or low-contrast shooting environments, the built-in auto focus assist beam will automatically light on to make it easier for auto focus. The beam will light up only when auto focus is difficult and get out as soon as the auto focus becomes correct.

If you want to turn off the auto focus assist beam, set the "AF" to "OFF" in the C.Fn settings.

- If you find the auto focus assist beam does not light up, this is because the camera has got a correct auto focus.
- Camera models that supports auto focus assist beam: X-PRO2, X-T20, X-T2, X-T1, GFX50S, GFX50R.

| Position  | Effective Range        |
|-----------|------------------------|
| Center    | 0.6-10m / 2.0-32.8feet |
| Periphery | 0.6-5m / 2.0-16.4feet  |

### Bounce Flash

By pointing the flash head toward a wall or ceiling, the flash will bounce off the surface before illuminating the subject. This can soften shadows behind the subject for a more natural-looking shot. This is called bounce flash.

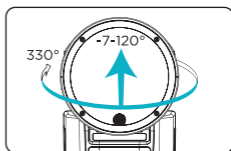

To set the bounce direction, hold the flash head and turn it to a satisfying angle.

- If the wall or ceiling is too far away, the bounced flash might be too weak and result in underexposure.
- The wall or ceiling should be a plain, white color for high reflectance. If the bounce surface is not white, a color cast may appear in the picture.

## ZOOM: Setting the Flash Coverage

The flash coverage can be set automatically or manually. It can be set to match the lens focal length from 28mm to 105mm (135 system). In auto zoom mode, the focal length changes in response to the camera's zoom lens to provide optimal flash results.

Choose APS or 135 system in the C.Fn-ZOOM.

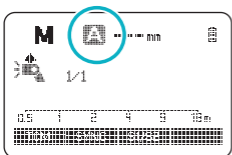

In manual zoom mode, press the **< ZOOM >** button.

- Turn the select dial to change the flash coverage.
- If **< A >** is displayed, the flash coverage will be set automatically.



- If you set the flash coverage manually, make sure it covers the lens focal length so that the picture will not have a dark periphery.

## Low Battery Warning

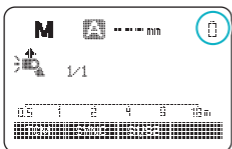

If the battery power is low, **< ⚡ >** will appear and blink on the LCD panel. Please replace the battery immediately.



## C.Fn: Setting Custom Functions

Press the menu button to enter C.Fn settings.

| Custom Function Signs | Function                      | Options | Settings & Descriptions  |
|-----------------------|-------------------------------|---------|--|
| m/ft                  | Distance indicator            | m       | m  |
|                       |                               | ft      | Feet   |
| AF                    | AF-assist beam                | ON      | ON   |
|                       |                               | OFF     | OFF  |
| STBY                  | Auto sleep setting            | ON      | ON   |
|                       |                               | OFF     | OFF  |
| RX STBY               | Receiver auto power off timer | 60 min  | Power off automatically after 60 minutes of idle use when the flash is set.  |
|                       |                               | 30 min  | As a receiver unit. Power off automatically after 30 minutes of idle use when the flash is set as a receiver unit. |
| SCAN                  | Scan the spare channel        | OFF     | OFF  |
|                       |                               | START   | Start to scan the spare channel  |
| CH                    | Wireless Channel              | 01-32   | Choose channels from 01-32   |
| ID                    | ID                            | OFF     | OFF  |
|                       |                               | 01-99   | Choose any figure from 01-99   |
| BEEP                  | Beeper                        | ON      | ON   |
|                       |                               | OFF     | OFF  |
| LIGHT                 | Backlighting time             | 12sec   | Off in 12 sec.   |
|                       |                               | OFF     | Always off   |
|                       |                               | ON      | Always lighting  |
| LCD                   | LCD contrast ratio            | -3~+3   | 7 levels   |
| ZOOM                  | Zoom display                  | APS     | APS system   |
|                       |                               | 135     | 135 system   |

- The "**Verx.x**" in the top-right corner refers to the software version.
- Turn the select dial to select the custom function No. and its parameters.
- Press set button to select the custom function No. and confirm its setting.
- After you set the custom function and press **< MENU >** menu button, the camera will be ready to shoot.
- Press and hold the function button 1 **< CLEAR >** in the **MENU** interface until "**OK**" is displayed on the panel, which means the parameters in C.Fn are reset.

# Protection Functions

## Over - Temperature Protection

- To avoid overheating and deteriorating the flash head, do not fire more than 100 continuous flashes in fast succession at 1/1 full power. After 100 continuous flashes, allow a rest time of at least 10 minutes.
- If you fire more than 100 continuous flashes and then fire more flashes in short intervals, the inner over-temperature protection function may be activated and make the recycle time over 10 seconds. If this occurs, allow a rest time of about 10 minutes, and the flash unit will then return to normal.
- When the over-temperature protection is started,  is shown on the LCD display.

### Number of flashes that will activate over-temperature protection:

| Power Output Level | Number of Flashes |
|--------------------|-------------------|
| 1/1                | 100               |
| 1/2 (+0.1~+0.9)    | 150               |
| 1/4 (+0.1~+0.9)    | 300               |
| 1/8 (+0.1~+0.9)    | 300               |
| 1/16 (+0.1~+0.9)   | 1100              |
| 1/32 (+0.1~+0.9)   | 3500              |
| 1/64 (+0.1~+0.9)   | 3500              |
| 1/128 (+0.1~+0.9)  | 3500              |
| 1/256 (+0.1~+0.9)  | 3500              |

**Note:** Numbers of flashes of over-temperature protection are different in different zoom values and different levels.

### Number of flashes that will activate over-temperature protection in HSS mode:

| Power Output Level | Number of Flashes |
|--------------------|-------------------|
| 1/1                | 60                |
| 1/2 (+0.1~+0.9)    | 70                |
| 1/4 (+0.1~+0.9)    | 100               |
| 1/8 (+0.1~+0.9)    | 100               |
| 1/16 (+0.1~+0.9)   | 100               |
| 1/32 (+0.1~+0.9)   | 100               |
| 1/64 (+0.1~+0.9)   | 100               |
| 1/128 (+0.1~+0.9)  | 100               |
| 1/256 (+0.1~+0.9)  | 100               |

## Technical Data

|   |   |
|---|---|
| <b>Model</b>                                    | FPLFSMZLXPF   |
| Compatible Cameras                              | FUJIFILM cameras (TTL auto flash)   |
| Power (1/1 output)                              | 76Ws  |
| Flash Coverage                                  | 28 to 105mm or 18 to 69mm   |
|   | • Auto zoom (flash coverage is set automatically to match the lens focal length and image size)   |
|   | • Manual zoom   |
|   | • Swinging/tilting flash head (bounce flash): 0 to 330° horizontally and -7° to 120° vertically.  |
| Flash Duration                                  | 1/300 to 1/20000 seconds  |
| <b>Exposure Control</b>                         |   |
| Exposure Control System                         | TTL auto flash and manual flash.  |
| Flash Exposure Compensation (FEC)               | Manual: ±3 steps with 1/3 increment each step.  |
| Sync Mode                                       | High-speed sync (up to 1/8000 seconds), first-curtain sync, and second-curtain sync.  |
| Multi Flash                                     | Provided (up to 90 times, 100Hz)  |
| <b>Wireless Flash (Radio 2.4G Transmission)</b> |   |
| Wireless Function                               | Transmitter, Receiver, Off  |
| Transmitter Unit Groups                         | M, A, B, C  |
| Controllable Receiver Groups                    | A, B, C, D, E (E group can be controlled by R2 series flash trigger)  |
| Transmission Range (approx.)                    | 100m  |
| Channels  | 32 (01-32)  |
| ID  | OFF/01-99   |
| <b>Auto Focus Assist Beam</b>                   |   |
| Effective Range (approx.)                       | Center: 0.6-10m / 2.0-32.8feet  |
|   | Periphery: 0.6-5m / 2.0-16.4feet  |
| <b>LED Modeling Lamp</b>                        |   |
| Power   | 2w  |
| Color Temperature                               | 3300K±200K  |
| <b>Power Supply</b>                             |   |
| Built-in Lithium Battery                        | 7.2V / 2980mAh  |
| Recycle Time                                    | Approx. 1.3 seconds. Green LED indicator will light up when the flash is ready.   |
| Number of Flashes at 1/1 step                   | Approx. 500   |
| Power Saving                                    | Power off automatically after approx. 90s of idle use when set as a transmitter unit.<br>Screen sleep automatically after approx. 60min (or 30min) of idle use when set as a receiver unit. |
| Sync Triggering Mode                            | Hot shoe, 2.5mm sync cord   |
| <b>Dimension</b>                                |   |
| W x H x D                                       | 6.14" x 2.99" x 4.88"   |
| Net Weight Without Battery≈                     | 466g  |
| Net Weight With Battery≈                        | 580g  |

\*Specifications and data may subject to changes without notice.

## Troubleshooting

If there is a problem, refer to this Troubleshooting Guide.

### **The camera flash does not fire.**

- The camera flash is not attached securely to the camera.  
→ Attach the camera's mounting foot securely to the camera.
- The electrical contacts of the camera flash and camera are dirty.  
→ Clean the contacts.

### **The power turns off by itself.**

- After 90 seconds of idle operation, auto power off took effect if the flash is set as a transmitter unit.  
→ Press the shutter button halfway or press any flash button to wake up.
- After 60 minutes (or 30 minutes) of idle operation, the flash enter sleep mode if it is set as receiver unit.  
→ Press any flash button to wake up.

### **Auto zoom does not work.**

- The camera flash is not attached securely to the camera.  
→ Attach the camera flash's mounting foot to the camera.

### **The flash exposure is underexposed or overexposed.**

- You used high-speed sync.  
→ With high-speed sync, the effective flash range will be shorter. Make sure the subject is within the effective flash range displayed.
- You used manual flash mode.  
→ Set the flash mode to TTL or modify the flash output.

### **Photos have dark corners or only parts of the target subject are illuminated.**

- The focal length of lens exceeds the flash coverage.  
→ Check the flash coverage you set. This flash unit has the flash coverage between 28 and 105mm or 18 and 69mm, which fits medium - format cameras.

## Firmware Upgrade

1. This product supports firmware upgrade through the USB-C port, please use USB-C cable (sold separately).
2. As the firmware upgrade needs the support of **Flashpoint F3** software, please download and install the "**Flashpoint F3 firmware upgrade software**" before upgrading. Then, choose the related firmware file.
3. Please refer to the latest electronic version of the instruction manual.

## Compatible Camera Models

FUJIFILM cameras are divided into three kinds according to their different Controlling ways to camera flash:

|   |  |
|---|--|
| A | X-Pro2, X-T20, X-T2, X-T1, X-T3, X-T4, X-T30, GFX50S, GFX50R |
| B | X-Pro1, X-T10, X-E1, X-A3                                    |
| C | X100F, X100T   |

### Compatible camera models and functions support:

| Camera | Camera Flash |      |     |                |      |     |             |
|--------|--------------|------|-----|----------------|------|-----|-------------|
|        | TTL Flash    |      |     | M Manual Flash |      |     | Multi Flash |
|        | Standard     | REAR | HSS | Standard       | REAR | HSS |             |
| A      | √            | √    | √   | √              | √    | √   | √           |
| B      | √            | --   | --  | √              | --   | --  | √           |
| C      | √            | √    | √   | √              | √    | √   | √           |

| Camera | 2.4G Wireless Control |      |     |              |      |     |             |
|--------|-----------------------|------|-----|--------------|------|-----|-------------|
|        | TTL Flash             |      |     | Manual Flash |      |     | Multi Flash |
|        | Standard              | REAR | HSS | Standard     | REAR | HSS |             |
| A      | √                     | √    | √   | √            | √    | √   | √           |
| B      | √                     | --   | --  | √            | --   | --  | √           |
| C      | √                     | √    | --  | √            | √    | --  | √           |

| Camera | AF Assist Beam |
|--------|----------------|
| A      | √              |
| B      | --             |
| C      | --             |

- X100T do not have second curtain sync (REAR) function.
- The AF assist beam will light up when the shutter is at low speed (<200).
- This table only lists the tested camera models, not all Sony cameras. For the compatibility of other camera models, a self-test is recommended.
- Rights to modify this table are retained.

## Maintenance

- Shut down the device immediately should abnormal operation be detected.
- Avoid sudden impacts and the product should be dedusted regularly.
- It is normal for the flash tube to be warm when in use. Avoid continuous flashes if unnecessary.
- Maintenance of the flash must be performed by our authorized maintenance department which can provide original accessories.
- This product, except consumables e.g. flash tube, is supported with a one-year warranty.
- Unauthorized service will void the warranty.
- If the product had failures or was wetted, do not use it until it is repaired by professionals.
- Changes made to the specifications or designs may not be reflected in this manual.

## FCC Warning

This device complies with part 15 of the FCC Rules. Operation is subject to the following two conditions: (1) This device may not cause harmful interference, and (2) this device must accept any interference received, including interference that may cause undesired operation.

Any Changes or modifications not expressly approved by the party responsible for compliance could void the user's authority to operate the equipment.

**Note:** This equipment has been tested and found to comply with the limits for a Class B digital device, pursuant to part 15 of the FCC Rules. These limits are designed to provide reasonable protection against harmful interference in a residential installation. This equipment generates uses and can radiate radio frequency energy and, if not installed and used in accordance with the instructions, may cause harmful interference to radio communications. However, there is no guarantee that interference will not occur in a particular installation. If this equipment does cause harmful interference to radio or television reception, which can be determined by turning the equipment off and on, the user is encouraged to try to correct the interference by one or more of the following measures:

- ▶ Reorient or relocate the receiving antenna.
- ▶ Increase the separation between the equipment and receiver.
- ▶ Connect the equipment into an outlet on a circuit different from that to which the receiver is connected.
- ▶ Consult the dealer or an experienced radio/TV technician for help.

The device has been evaluated to meet general RF exposure requirement.

The device can be used in portable exposure condition without restriction.

## One Year Flashpoint Limited Warranty

Flashpoint warrants to the original purchaser that your Flashpoint product shall be free from defects in material and workmanship for the period of one (1) year from the date of purchase (or delivery as may be required in certain jurisdictions), or thirty (30) days after replacement, whichever comes later.

Flashpoint's entire liability and your exclusive remedy for any breach of warranty shall be, at Flashpoint's option, to repair or replace the hardware, provided that the hardware is returned to the point of purchase or such other place as Flashpoint may direct with a copy of the sales receipt or dated itemized receipt. Flashpoint may, at its option, replace your product, offer to provide a functionally equivalent product, or repair any product with new, refurbished or used parts as long as such parts are in compliance with the product's technical specifications. Any replacement hardware product will be warranted for the remainder of the original warranty period or thirty (30) days, whichever is longer, or for any additional period of time that may be applicable in your jurisdiction. If the product has been discontinued, the warranty provider reserves the right to replace it with a model of equivalent quality and function.

This warranty does not cover problems or damage resulting from accident, abuse, misapplication, or any unauthorized repair, modification or disassembly, improper operation or maintenance, normal wear and tear, or usage not in accordance with product instructions or connection to improper voltage supply, use of consumables, such as replacement batteries, not supplied by Flashpoint, except where such restriction is prohibited by applicable law.

Except where prohibited by applicable law, this warranty is nontransferable and is limited to the original purchaser and the country in which the product was purchased. This warranty gives you specific legal rights, and you may also have other rights, including a longer warranty duration that may vary under local laws.

To start a warranty claim contact the Flashpoint Customer Service Department to obtain a return merchandise authorization ("RMA") number, and return the defective product to Flashpoint, along with the RMA number and proof of purchase.



## Question about our product line? Need Product Support?

We are proud of our products and celebrate our customers. We are with you, from product selection to everyday use. Be secure with your purchase and reach us as you need.

 212-647-9300

 [brands@adorama.com](mailto:brands@adorama.com)

 Adorama Brands,  
42 West 18th Street,  
New York, NY 10011

You can always contact us at [BRANDS@ADORAMA.COM](mailto:BRANDS@ADORAMA.COM) for personal technical support.

Our website contains a wide range of Support and FAQ pages with valuable technical assistance.

Flashpoint is a registered trademark of ADORAMA CAMERA.

© 2024 Adorama Camera, Corp.

All Rights Reserved.

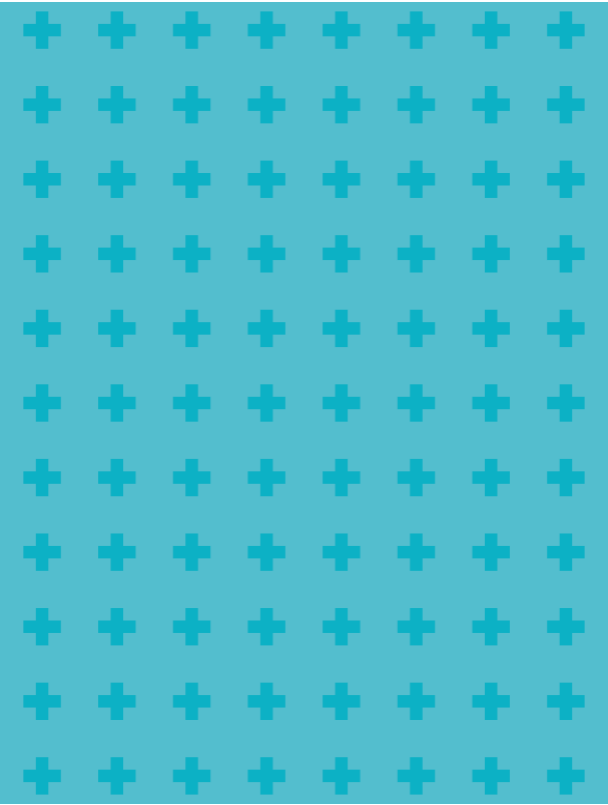

FLASHPOINTLIGHTING

Scan to follow our  
official instagram

[WWW.FLASHPOINTLIGHTING.COM](http://WWW.FLASHPOINTLIGHTING.COM)